



MGSI-03P3-100~110K User Manual

Preface

The manual is intended to provide detailed information of product information, installation, application, trouble shooting, precautions and maintenance of series grid-tied solar inverters. The manual does not contain all information of the photovoltaic system. Please read this manual carefully and follow all safety precautions seriously before any moving, installation, operation and maintenance to ensure correct use and high performance of operation on the inverter.

The use of the series grid-tied solar inverters must comply with local laws and regulations on grid-tied power generation.

The manual needs to be kept well and be available at all times.

All rights reserved. The contents in this document are subject to change without notice.

There might be some deviations on actual inverter and data due to product updating, please refer to the actual product.

Content

Preface	i
Content	ii
1 Safety precautions	1
1.1 Warning marks	1
1.2 Safety guidance	2
1.2.1 Transport and installation	3
1.2.2 Grid-connected operation	3
1.2.3 Maintenance and inspection	4
1.2.4 Waste disposal	4
2 Product overview	5
2.1 PV grid-connected power generation system	5
2.1.1 Supported grid connection structure	5
2.2 Product appearance	6
2.4 Product model	7
2.5 Outline dimension and weight	8
2.7 LCD display and operation	9
2.7.1 LCD display and operation	9
2.7.2 LED indicator definition	9
2.7.3 LCD display wake-up	10
2.7.4 Language Setting	11
2.7.5 COM Address Setting	11
2.7.6 Date & Time Setting	11
2.7.7 Power on Setting	12
2.7.8 DC Input Setting	12
2.7.9 Country Setting	13
2.7.10 Volt Level Setting	13
2.7.11 Anti-Reflex Setting	13
2.7.12 Restore Factory Setting	14

2.8 Bottom of chassis	14
3 Storage	15
4 Installation	15
4.1 Unpacking confirmation	16
4.2 Preparation before installation	17
4.2.1 Installation tool	17
4.2.2 Installation environment	17
4.3 Space requirements	18
4.4 The size of installation hanging board	20
4.5 Bracket installation	20
4.6 Wall installation	21
4.7 Installation of inverter	22
5 Electrical connection	23
5.1 Overview of electrical connection	23
5.2 Connect the protective earth wire	23
5.3 Connection of photovoltaic string	24
5.4 Three-phase inverter grid connection	26
5.4.1 Cable specifications	26
5.4.2 Terminal block grid connection	27
5.4.3 Parallel connection requirements of multiple inverters	28
5.5 Connect the communication line	29
5.5.1 Interface description	29
5.5.2 DRM interface description	30
6 Running	32
6.1 Inspection before running	32
6.2 Inverter grid-connected running	32
6.3 Inverter stop	33
6.4 Daily maintenance and inspection	33
6.4.1 Periodic maintenance on the inverter	33
6.4.2 Maintenance guidance	34
7 Fault isolation	37
8 Appendix	42

1 Safety precautions

the series grid-tied solar inverters are designed and tested strictly in accordance with relevant international safety standards. As an electrical and electronic device, all relevant safety regulations must be strictly complied during installation, operation, and maintenance. Incorrect use or misuse may result in:

- Injury to the life and personal safety of the operator or other people.
- Damage to the inverter or other property belonging to the operator or other people.

In order to avoid personal injury, damage to the inverter or other devices, please strictly observe the following safety precautions.

This chapter mainly describes various warning symbols in operation manual and provides safety instructions for the installation, operation, maintenance and use of the series grid-tied solar inverters

1.1 Warning marks

Warning marks is alerting users to conditions which may cause serious physical injury or death, or damage to the device. They also tell users how to prevent the dangers. The warning marks used in this operation manual are shown below:

Mark	Name	Instruction	Abbreviation
 Danger	Danger	Serious physical injury or even death may occur if not follow relevant requirements.	
 Warning	Warning	Physical injury or damage to the device may occur if not follow relevant requirements.	
 Forbid	Electrostatic sensitive	Damage may occur if relevant requirements are not followed.	
 Hot	High temperature	Do not touch the base of the inverter as it will become hot.	
Note	Note	The procedures taken for ensuring proper operation.	Note

1.2 Safety guidance

	<ul style="list-style-type: none"> ● After receiving this product, first please confirm the product package is intact. If any question, please contact the logistic company or local distributor immediately. ● The installation and operation of PV inverter must be carried out by professional technicians who have received professional trainings and thoroughly familiar with all the contents in this manual and the safety requirements of the electrical system. ● Do not carry out cable connection/disconnection, cover open for inspection and unit replacement operations on the inverter when power is connected. Before wiring and inspection, users must confirm the breakers on DC and AC side are disconnected and wait for at least 5 minutes.
	<ul style="list-style-type: none"> ● Ensure there is no strong electromagnetic interference caused by other electronic or electrical devices around the installation site. ● Do not refit the inverter unless authorized. ● All the electrical installation must conform to local and national electrical standards.
	<ul style="list-style-type: none"> ● Do not touch the housing of the inverter or the radiator to avoid scald as they may become hot during operation
	<ul style="list-style-type: none"> ● Ground with proper technics before operation.
	<ul style="list-style-type: none"> ● Do not open the surface cover of the inverter unless authorized. The electronic components inside the inverter are electrostatic sensitive. Do take proper anti-electrostatic measures during authorized operation.
	<ul style="list-style-type: none"> ● Grounding mark. The inverter must be reliably grounded.
	<ul style="list-style-type: none"> ● Discharging mark.Ensure that DC and AC side circuit breakers have been disconnected and wait at least 5 minutes before wiring and checking.
<p>Note: Technical personnel who can perform installation, wiring, commissioning, maintenance, troubleshooting and replacement of the series grid-tied solar inverters must meet the following requirements:</p>	
<ul style="list-style-type: none"> ● Operators need professional training. ● Operators must read this manual completely and master the related safety precautions. ● Operators need to be familiar with the relevant safety regulations for electrical systems. ● Operators need to be fully familiar with the composition and operating principle of the entire 	

grid-tied photovoltaic power generation system and related standards of the countries/regions in which the project is located.

Operators must wear personal protective equipment.

1.2.1 Transport and installation



- During storage or transport, ensure the inverter package and the chassis is intact, dry and clean.
- The movement and installation of the inverter require at least two persons due to its heavy weight.
- Select proper tools for movement and installation to ensure the inverter can operate normally and avoid physical injury. The installation personnel must take mechanical protective measures such as wearing anti-drop shoes or working clothes to protect physical security.
- The inverter must be installed by professional technicians.
- Do not store or install the inverter on or Turn on to flammable and explosive objects-
- Do not install the inverter in places easily accessible to children or other public.
- Remove the metal accessories in hands eg ring or bracelet before device installation and electrical connection to avoid electric shock.
- The solar cell panel exposed to the sunlight may generate dangerous voltage. Users must cover the solar cell with fully-lightproof materials before electrical connection
- The inverter input voltage cannot exceed the max input voltage, otherwise the inverter may be damaged.
- PV grid-connected inverter is not applicable to the positive or negative ground system of solar cell panel.
- Ensure inverter PE is grounded properly, otherwise the inverter cannot run normally.
- Ensure the inverter is installed firmly and electrical wiring is reliable.

Note: PV grid-connected inverter is only suitable for crystalline silicon-type solar battery component.

1.2.2 Grid-connected operation



- Permissions by local electric power agency must be obtained and the inverter grid-connected power generation operation must be done by professional technicians.
- All electrical connections must meet the electrical standards of the

	<p>countries/regions in which the project is located.</p> <ul style="list-style-type: none"> ● Ensure the inverter is installed firmly and electrical wiring is reliable before operating on the inverter. ● Do not open the inverter when it is running or connecting power
--	--

1.2.3 Maintenance and inspection

	<ul style="list-style-type: none"> ● The maintenance, inspection and repair of the inverter must be done by well trained and qualified professional technicians. ● Contact distributor or manufacture for inverter repair. ● In order to avoid irrelevant personnel entering the maintenance area during maintenance, temporary warning labels must be placed to warn non-professionals to enter or please isolate with fences. ● Before carrying out any maintenance operations, users must disconnect the breaker on grid side, then disconnect the breaker connected to the PV component and wait at least 5 minutes until the internal parts of the inverter are fully discharged. ● The internal of inverter are mostly electrostatic-sensitive circuits and parts, users must follow electrostatic protection rules and take anti-electrostatic measures. ● Do not use components provided by other companies when repairing the inverter. ● The inverter can be started again for grid-connected power generation only after confirming there is no fault that may impact the safety performance of the inverter. ● Do not get Turn on to or touch the grid or any metal conductive parts in the PV power generation system during operation, otherwise electric shock or fire may occur. Take note of any safety marks and instructions such as "Danger, electric shock risk".
---	--

1.2.4 Waste disposal

	<ul style="list-style-type: none"> ● Do not dispose of the inverter together with household waste. The user has the responsibility and obligation to send it to the designated organization for recycling and disposal.
---	--

2 Product overview

This chapter mainly describes the appearance, package accessories, nameplate and technical parameters of the grid-connected inverter.

2.1 PV grid-connected power generation system

PV grid-connected power generation system is comprised of solar battery component, grid-connected inverter, power energy gauging device and public grid.

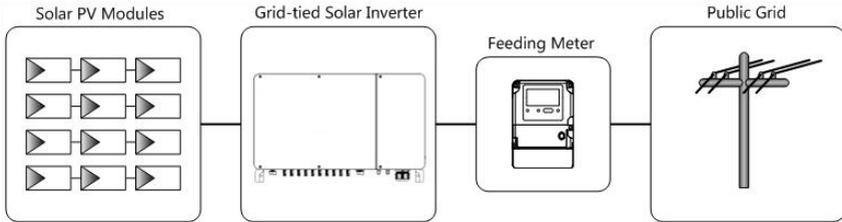

Fig 2.1 Application of PV grid-connected inverter

The PV grid-connected inverter is the core part of solar PV grid-connected power generation system. The sunlight can be converted through PV panel to DC power, which further converted by grid-tied inverter to the sine AC current with the same frequency and phase position as the public grid, then feedback the AC power to the grid.



- It is recommended that the PV array to be installed conforms to IEC 61730 class A standards.

2.1.1 Supported grid connection structure

series grid-tied solar inverters support TN-S, TN-C, TN-C-S , TT and IT grid connection. When applied to the TT connection, the N-to-PE voltage should be less than 30V.

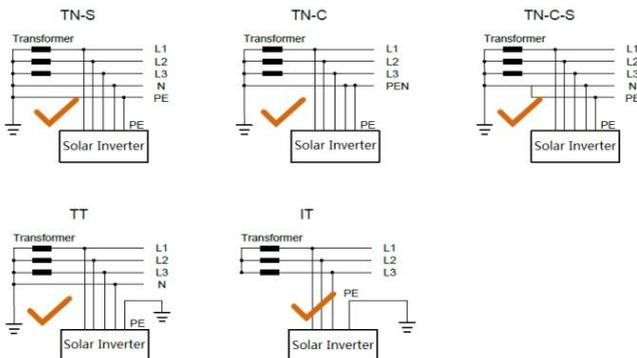

Figure 2.2 Type of grid

2.2 Product appearance

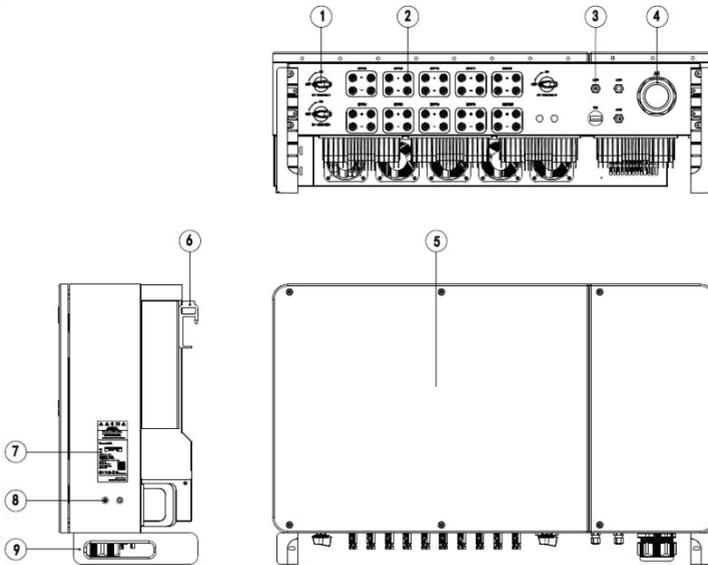

Fig 2.3 Appearance of 100-110 kW three-phase PV inverter

Table 2-1 Instruction for key cosmetic parts of three-phase PV inverter

	name	illustrate
1	DC switch	Switch on or switch off DC input
2	DC input interface	Inverter DC input port, connect to PV array
3	Communication interface	RS485 communication port and its extension port EXT
4	AC terminal	Inverter AC output port, connect to public grid
5	LED light	Indicate the inverter's current working condition
6	Hanging ear	Install the inverter in the flip chart
7	Nameplate	Indicate the rated inverter parameters
8	Earthing terminal	Two nos, connect at least one of them
9	Base of the handle	Total two nos, for handling inverter

Icons	Instruction
	<ul style="list-style-type: none"> ● TUV certification mark. The inverter is certified by TUV.
	<ul style="list-style-type: none"> ● CE certification mark. The inverter complies with the CE directive.
	<ul style="list-style-type: none"> ● CQC certification mark. The inverter passed CQC certification.
	<ul style="list-style-type: none"> ● EU WEEE mark. The inverter cannot be disposed of as domestic waste.

2.5 Outline dimension and weight

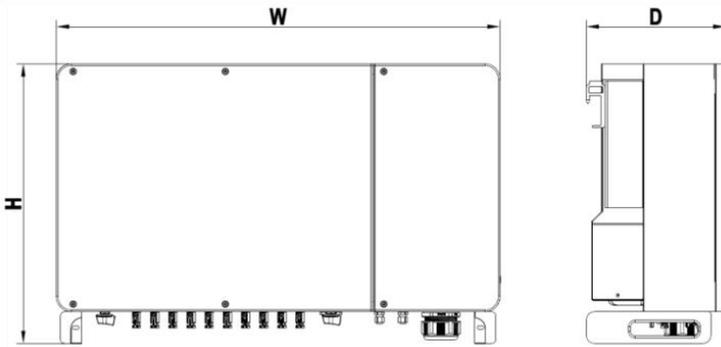

Fig 2.5 Outline dimension and weight of the inverter

Table 2-3 Dimension and net weight of the inverter

Model	Height(mm)	Width(mm)	Depth(mm)	Net weight(kg)
100kW	660	1050	330	95
110kW	660	1050	330	98

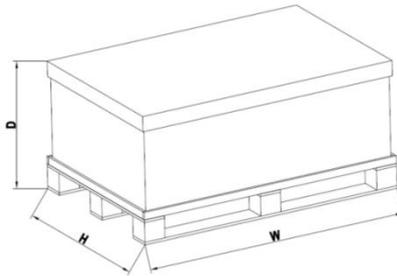
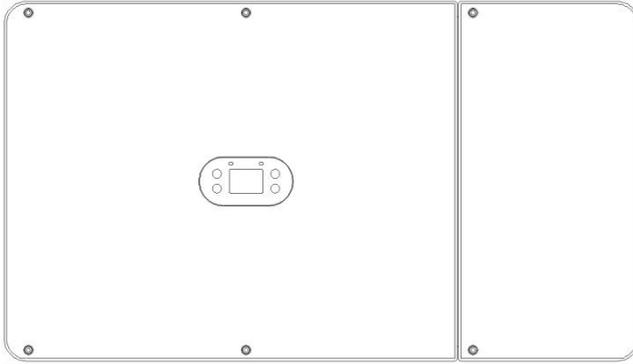

Fig 2.6 Dimension of paper package

Table 2-4 Package dimension and gross weight

Model	Height (mm)	Width (mm)	Depth (mm)	Weight (kg)	Package material
100kW	830	1260	585	120	Pallet + cartons
110kW	830	1260	585	123	Pallet + cartons

2.7 LCD display and operation



2.7.1 LCD display and operation

The LCD display shows the operating status of the inverter and various parameter information, as well as setting the inverter parameters.



Screen button definition

ESC	UP
Return to the previous level display or cancel	Switch up or add 1 to the current number
ENTER	DOWN
Go to the next level display or confirm	Switch down or current number minus 1

2.7.2 LED indicator definition

Green light	Yellow light	Red light
Always on: Grid-connected status Blinking: Waiting status	Green light blinking + yellow light blinking: software upgrade status	Always on: Fault

2.7.3 LCD display wake-up

After the LCD display detects the key operation action, it automatically turns on the backlight and enters the bright light display state; after 30 seconds of no key operation action, it automatically turns off the display backlight and enters the dark light hibernation mode.

1、 Main interface display

The main interface shows the inverter working status, power size and flow direction, RS485 communication, meter communication, fault information and system time.

2、 Menu interface display

In the main interface, you can enter the menu interface through any key operation, and then enter the sub-interface of each menu to view the inverter parameters through key operation.

PV Information
AC Output Information
Basic Information
Energy Information
Fault Information
Setting Information

3、 Function Setting

Enter the password from the Setting Info interface to enter the function setting menu, password: 123. The parameter value displayed after entering each function setting interface is the current parameter value set.

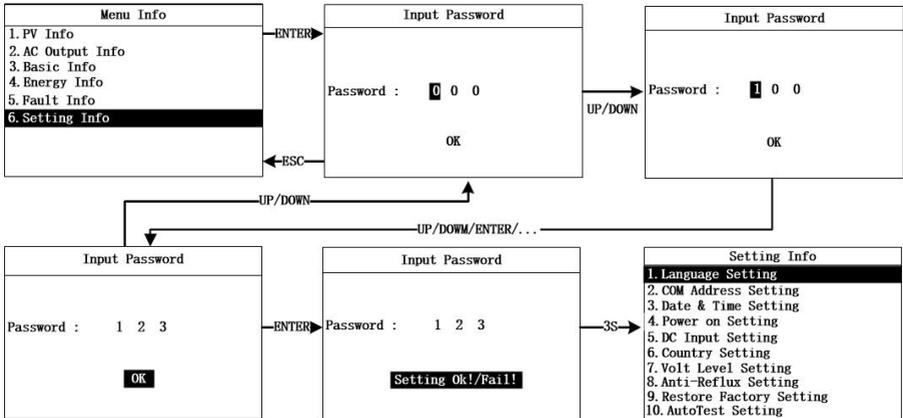

2.7.7 Power on Setting

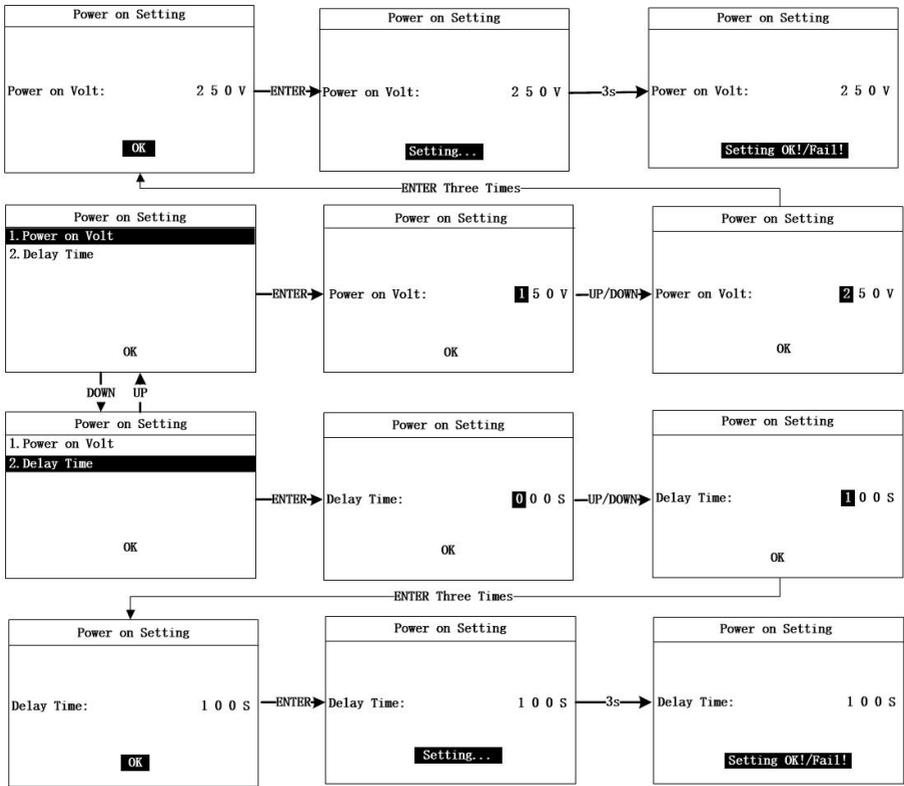

2.7.8 DC Input Setting

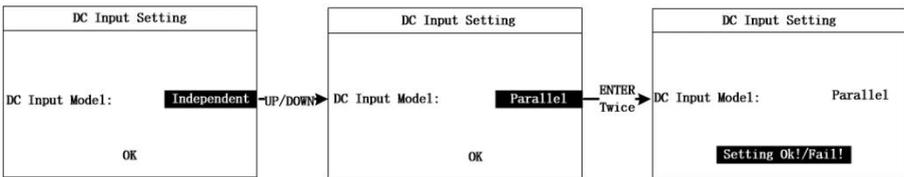

2.7.9 Country Setting

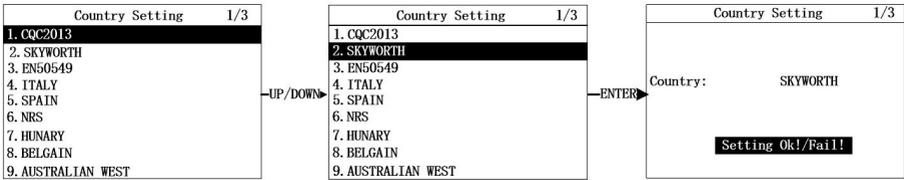

2.7.10 Volt Level Setting

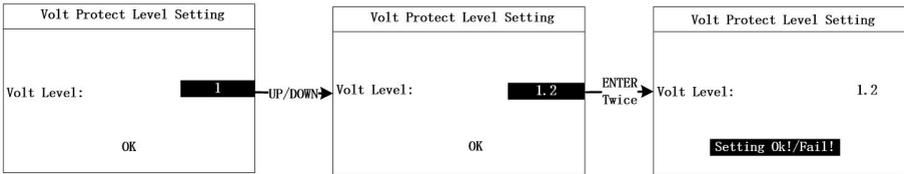

2.7.11 Anti-Reflux Setting

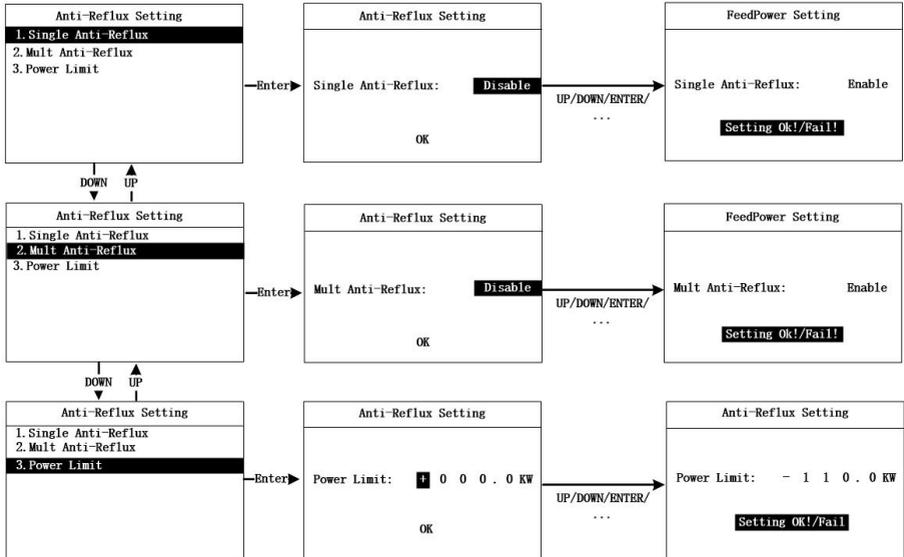

2.7.12 Restore Factory Setting

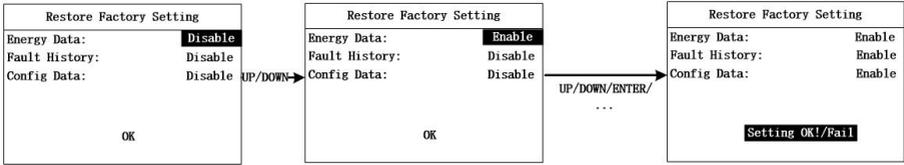

2.8 Bottom of chassis

MGSI-03P3-100~110K is equipped with three DC switches,

Each DC switch controls the DC terminal corresponding to its area. .

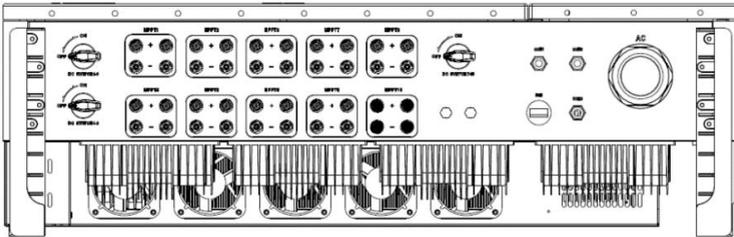

MGSI-100K-03P3

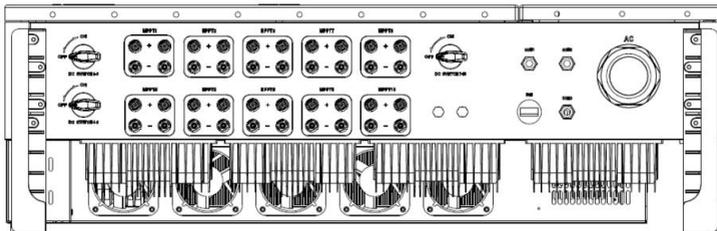

MGSI-110K-03P3

3 Storage

If the inverter is not put into use immediately, the storage of inverter should meet the following requirements:

- Do not remove the outer packing.
- The inverter needs to be stored in a clean and dry place, and prevent the erosion of dust and water vapor.
- The storage temperature should be kept at 30°C~+70°C, and the relative humidity should be kept at 5%RH~95%RH.
- The stacking of inverters is recommended to be placed according to the number of stacking layers in the original shipment. Place the inverter carefully during stacking to avoid personal injury or equipment damage caused by the falling of equipment.
- Keep away from chemically corrosive substances that may corrode the inverter.
- Periodic inspections are required. If damages are found by worms and rats, or packaging are found damaged, the packaging materials must be replaced in time.
- After long-term storage, inverters need to be inspected and tested by qualified personnel before put into use.

4 Installation

This chapter describes how to install the inverter and connect it to the grid-tied solar system (including the connection between solar modules, public grid and inverter).

Read this chapter carefully and ensure all installation requirements are met before installation. Only qualified electricians are allowed to install the inverter.

4.1 Unpacking confirmation

The inverter has been thoroughly tested and rigorously checked before delivery, but damage may still occur during transportation. Before unpacking, check carefully whether the product information in the order is consistent with that on the nameplate of the package box and whether the product package is intact. If any damage is detected, please contact the shipping company or the supplier directly. Please also provide photos of the damage to get our fastest and best service.

Store the idled inverter in its original package and take anti-moisture and anti-dust measures.

After taking the inverter out of the box, check the following items:

- (1) Confirm the inverter is intact and free from any damage;
- (2) Confirm there is operation manual, interface accessories and installation accessories inside the package box;
- (3) Confirm the deliverables inside the package box are intact and complete;
- (4) Check whether the product information in the order is consistent with that on the inverter nameplate;
- (5) The standard delivery list is shown below.

Standard deliverables of three-phase inverter:

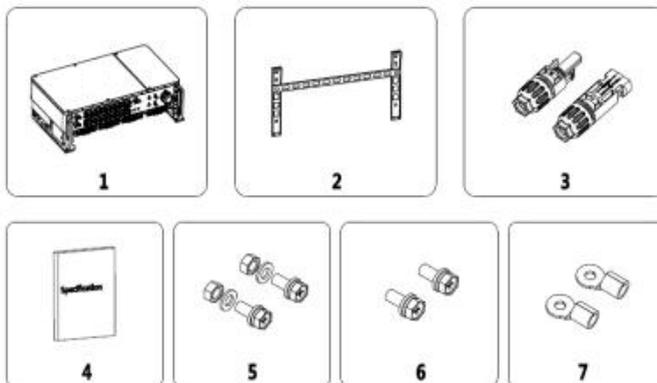

Fig 4.1 Deliverables of 100–110 kW three-phase inverter

Table 4-1 Deliverables of three-phase inverter

No	Name	Amount
1	Inverter	1
2	Installation bracket	1
3	DC connector	9 pairs(100kW)/10 pairs(110kW)/12 pairs(136kW)
4	Document	1
5	M10 combination bolt	4
6	M6 combination bolt	2
7	AC wire terminal	

Check above-mentioned items carefully and if any question, contact the supplier immediately.

4.2 Preparation before installation

4.2.1 Installation tool

Table 4-2 List of installation tool

No	Installation tool	Purpose
1	Marker	Indicate the installation hole
2	Electric drill	Drill holes in the bracket or on the wall
3	Hammer	Knock on the expansion bolt
4	Adjustable wrench	Fix the installation bracket
5	Inner hex screwdriver	Tighten the anti-theft screw and disassemble AC junction box
6	“Slotted” or “cross-head” screwdriver	AC wiring
7	Megameter	Measure the insulation performance and grounding impedance
8	Multimeter	Check the circuit and measure AC/DC voltage
9	Electric soldering iron	Solder the communication cable
10	Wire crimper	Crimp DC terminal
11	Hydraulic clamp	Crimp ring terminal for AC wiring

4.2.2 Installation environment

- (1) The inverter can be installed in indoor and outdoor environment.
- (2) During the operation of the inverter, the temperature of the chassis and heat sink will be relatively high.

Please do not install the inverter in the easily touched position.

- (3) Do not install inverters in areas where flammable and explosive materials are stored.
- (4) The inverter shall be installed in a well-ventilated environment to ensure good heat dissipation.
- (5) It is recommended to choose the installation site with shelter or build sunshade.

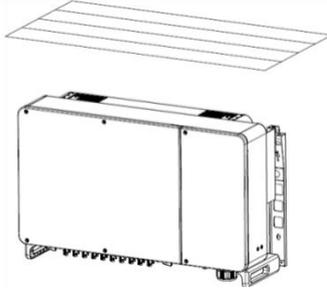

Fig 4.2 sunshade

- (6) The installation environment temperature is $-30^{\circ}\text{C} \sim 60^{\circ}\text{C}$;
- (7) The installation site should be far away from the electronic equipment with strong electromagnetic interference;
- (8) The installation site should be fixed and solid object surface, such as wall, metal support, etc;
- (9) The installation position shall ensure the reliable grounding of the inverter, and the grounding metal conductor material shall be consistent with the reserved grounding metal material of the inverter.

4.3 Space requirements

- (1) The height of installation position shall ensure that the line of sight and LED display light are on the same horizontal plane, so as to check the inverter status conveniently .

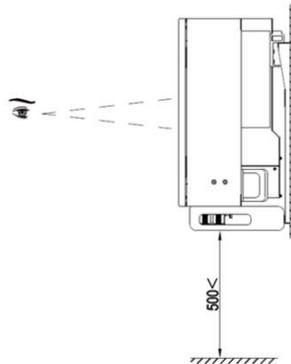

Fig 4.3 optimum installation height area

- (2) There is enough reserved space around the installation site to facilitate the disassembly and assembly of inverter and air convection. As shown in Figure 4.3.

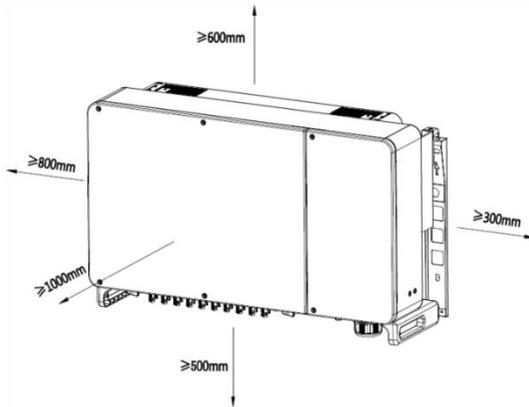

Fig 4.4 installation spacing of inverter

(3) When installing multiple inverters, a certain distance should be reserved between the inverters, as shown in Figure 4.4. At the same time, sufficient distance should be reserved between the upper and lower parts of the inverter to ensure good heat dissipation.

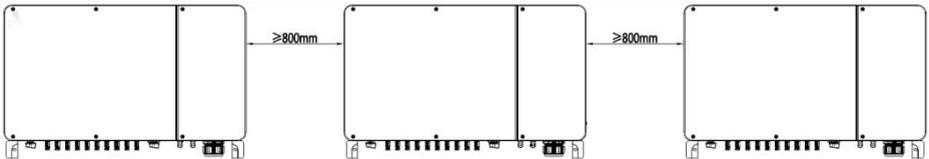

Fig 4.5 side by side installation dimension requirements

(4) The mounting surface shall be perpendicular to the horizontal line as shown in Figure 4.5. Please install the inverter vertically or backward $\leq 15^\circ$ to facilitate the heat dissipation of the machine. Do not tilt the inverter forward, horizontally, upside down, backward too much or roll it.

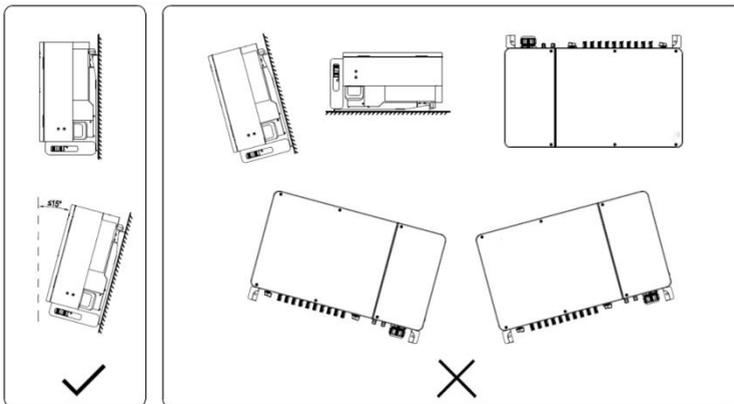

Fig 4.6 installation position of inverter

4.4 The size of installation hanging board

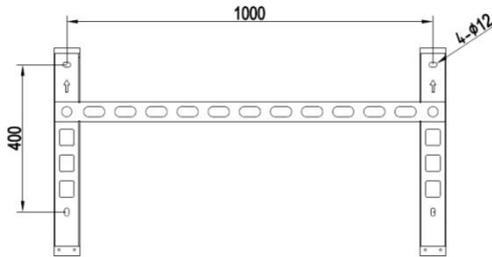
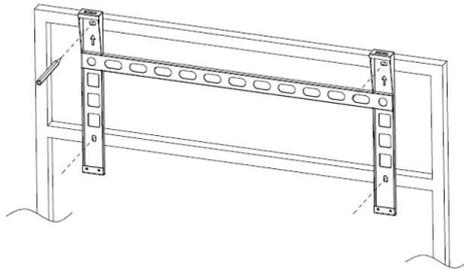

Fig 4.6 dimension drawing of installation hanging plate

4.5 Bracket installation

Step 1: Fix the hanging board on the photovoltaic bracket. Level the holes with a level ruler and mark it with a marking pen.



Step 2: Drill holes on the wall with electric drill.

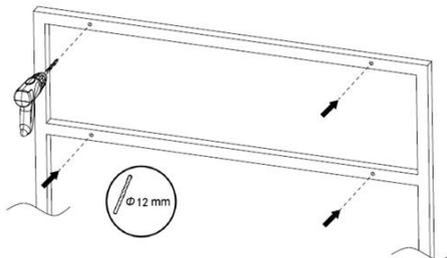

Step 3: Align the hanging plate with the hole position, and put the combination bolt (flat pad, spring pad, M10×40 bolt) through the hanging plate into the hole,, and fix it with the stainless steel nut, spring pad and flat pad delivered with the box. The tightening torque is 35N·m.

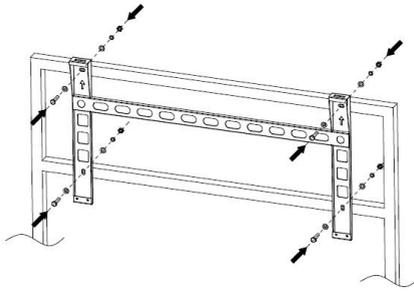

4.6 Wall installation

Step 1: Fix the hanging board at the wall mounting point. Level the holes with a level ruler and mark it with a marking pen.

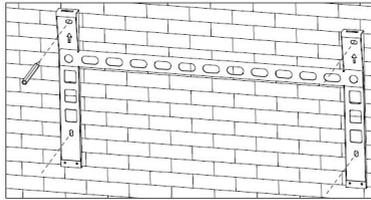

Step 2: Drill holes with impact drill and install expansion bolts. Users need to prepare expansion bolts by themselves, and it is recommended to use M10 × 95 stainless steel pressure explosion expansion bolt.

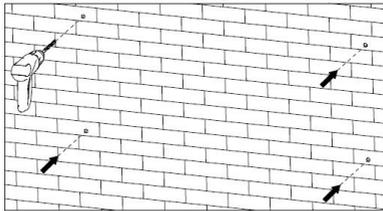

Step 3: Fix the hanging board. Clean the hole position, drive the expansion bolt into the hole with a rubber hammer, use a wrench to tighten the nut to fix the tail of the bolt, then remove the nut, elastic pad and flat pad, and then fix the wall hanging plate with a tightening torque of 35N·m.

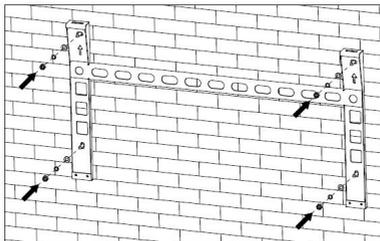

4.7 Installation of inverter

Step 1: Take the inverter out of the packing box.

Step 2: If the installation position is high, it is necessary to lift the inverter to the hanging board, use the lifting device to lift the inverter 100 mm from the ground, and then pause, and check the fastening of the lifting ring and rope. After confirming that the connection is firm, lift the inverter to the destination.

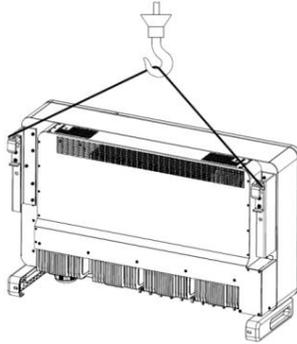

Step 3: Insert the hooks on the left and right sides of the inverter into the holes of the hanging board to ensure that the hanging ears and the grooves of the hanging board are well matched.

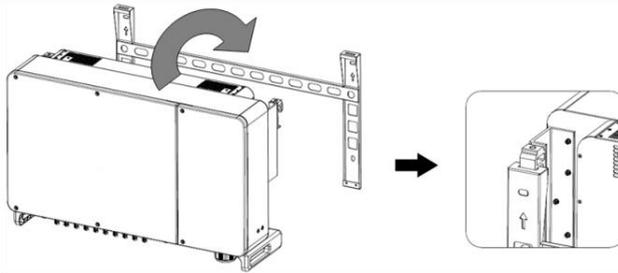

Step 4: Use two screws to fix the inverter between the left and right base holes of the chassis and the wall mount, and the tightening torque is $4.5\text{N}\cdot\text{m}$.

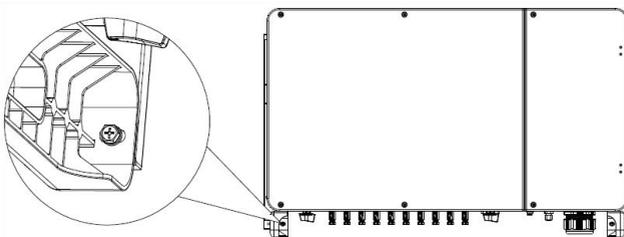

5 Electrical connection

5.1 Overview of electrical connection

This section presents the detailed contents and safety precautions related to electrical connection.

Fig 5.1 is the connection diagram for PV grid-connected system.

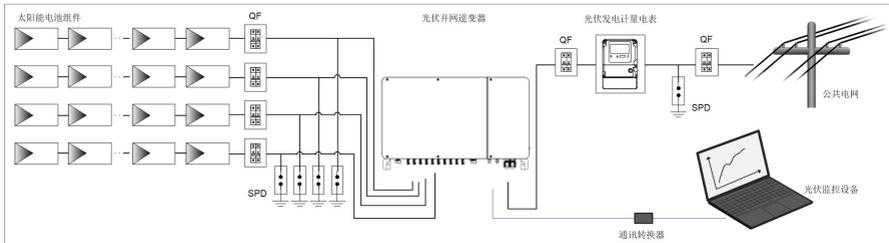

Fig 5.1 Connection diagram for PV grid-connected system

	<ul style="list-style-type: none"> ● Electrical connection must be carried out by professional technicians as wrong operation may cause damage to the device, physical injuries or even death during system operation. ● All the electrical installation must conform to the national and regulations concerning electrical safety regulations. ● Ensure all the cables are installed firmly according to the specified safety requirements and free from any damage. ● It is not allowed to turn on the AC and DC breakers before the inverter is electrically connected and checked.
Note	<ul style="list-style-type: none"> ● Read this section carefully and operate strictly according to the requirements. ● Note the rated voltage and current value specified in the manual as they cannot be exceeded.

5.2 Connect the protective earth wire

Step 1: Crimp OT terminal to ground wire.

Step 2: Remove the screw at the grounding position on the side of the chassis, fix and lock the ground wire with the screw, and the tightening torque is 7-9N·m.

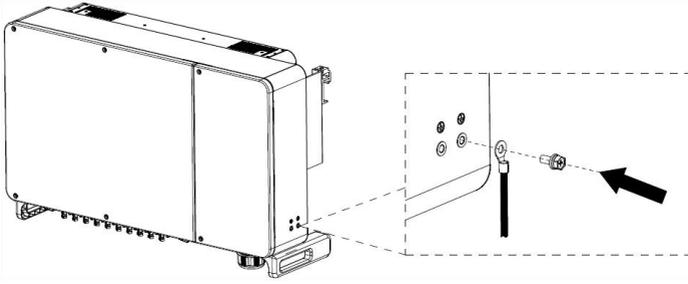

5.3 Connection of photovoltaic string

Step 1: Connect the outlet of PV board to the MC4 terminal delivered along with the inverter.

MC4 terminal crimping method is as follows:

(1) Connect the output cables of solar modules to the DC connector as fig 5.2 shows. Loosen the nut of connector and remove the isolation layer of the DC cable for about 15mm. Insert it into the connector and press until hear the lock sound. Finally tighten the nut to a torque of 2.5-3 Nm. The wiring of negative pole is the same as that of the positive pole. Ensure the poles of solar modules are well connected with the connectors.

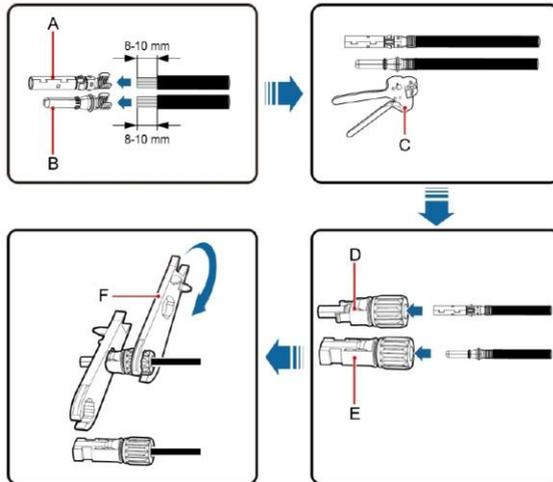

Fig 5.2 Connection of MC4 DC connector and PV string

(2) After the DC connector is connected, use a multimeter to measure the voltage of the DC input string, verify the polarity of the DC input cable, and ensure that the voltage of each string is within the allowable range of the inverter, as shown in Fig 5.3.

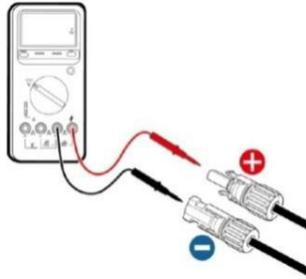
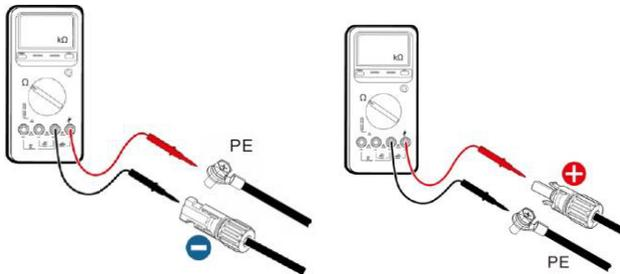

Fig 5.3 DC input voltage measuring

(3) After the DC connector is connected, you need to use a multimeter or megohmmeter to measure the insulation of the positive and negative terminals of each string to the ground, and the insulation is normal before you can access the inverter.



- a. Check the PV+ ground insulation impedance value of the PV series to ensure that the impedance value of each series is greater than $1\text{ M}\Omega$.
- b. Check the PV-to-ground insulation impedance value of the PV series to ensure that the impedance value of each series is above $1\text{ M}\Omega$.



- The PV string connected to inverter must adopt the DC connector configured especially for the inverter, do not use other connection devices without authorization from our company, otherwise damage to the device, unstable operation or fire may occur and our company will not undertake quality assurance or assume any direct or joint liability thereof.

Step 2: After connecting the terminal, inset it into the MC4 terminal of the machine.

- (1) Connect PV string to the inverter and ensure tightly-fastened, as shown in Fig 5.4;
- (2) When removing the DC connector from the inverter, insert the head of the straight screwdriver into the raised hole in the middle of the connector, and force the movable end of the connector to exit.

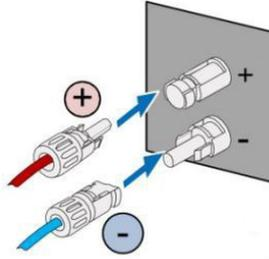

Fig 5.4 Connect PV string to inverter

5.4 Three-phase inverter grid connection

Table 5-1 Interface description of three phase photovoltaic inverter AC connector

Inverter AC connector interface	Three phase grid	remarks
L1	L1 (A)	
L2	L2 (B)	
L3	L3 (C)	
N	N(Neutral line)	
	PE (ground wire)	Must be connected

5.4.1 Cable specifications

The user can select connection cable according to the table below:

Table 2 Cable specifications

NO.	Cable	Type	Cable Specification
1	PE cable	Outdoors cable	Conductor cross sectional area $S_{PE} \geq S/2$
2	DC input cable	PV cable that meets 1100V standard	<ul style="list-style-type: none"> Conductor cross sectional area: 4~6 mm² Cable outer diameter:5.5mm~8mm
3	AC output cable (multi-core)	Multi-core outdoor cable	<ul style="list-style-type: none"> Cable outer diameter:22mm~67mm Copper core cable conductor cross Sectional area:70≤S≤240mm² Aluminum alloy cable or copper-clad aluminum cable conductor cross Sectional area:95≤S≤240mm² Conductor cross sectional area $S_{PE} \geq S/2$

NO.	Cable	Type	Cable Specification
4	AC output cable (single core)	Single-core outdoor cable	<ul style="list-style-type: none"> • Cable outer diameter: 11mm~35mm • Copper core cable conductor cross Sectional area: $70 \leq S \leq 240 \text{mm}^2$ • Aluminum alloy cable or copper-clad aluminum cable conductor cross Sectional area: $95 \leq S \leq 240 \text{mm}^2$ • Conductor cross sectional area $S_{PE} \geq S/2$

5.4.2 Terminal block grid connection

(1) As shown in the figure below, remove the right box cover of the machine.

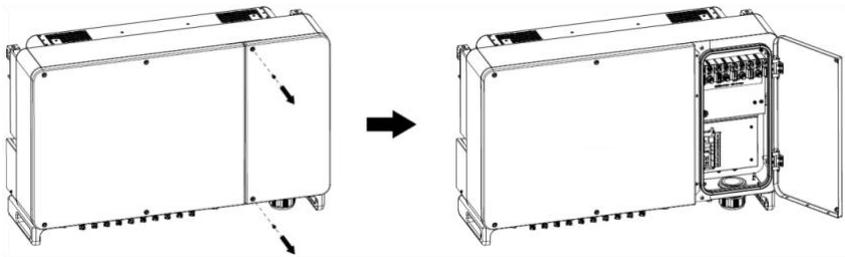

Fig 5.5 removing the machine cover

(2) According to Table 5-1, the three-phase public power grid L1, L2, L3, N (optional) and PE five wires are connected to the AC connector interface, and ensure that the conductor is not exposed and pressed firmly, as shown in 5.6.:

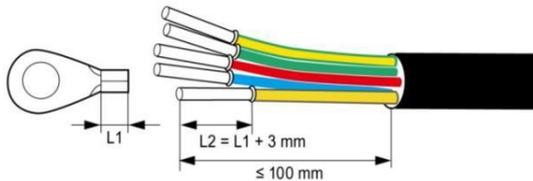

Fig 5.6 crimping cable terminals

(3) Then, according to figure 5.7, fix the L1, L2, L3, n (optional) and PE cables on the corresponding terminals of AC connection circuit board. The tightening torque of L1, L2, L3 and N is 20-30N · m, and the tightening torque of PE grounding is 4N · m; Then tighten the AC waterproof cap.

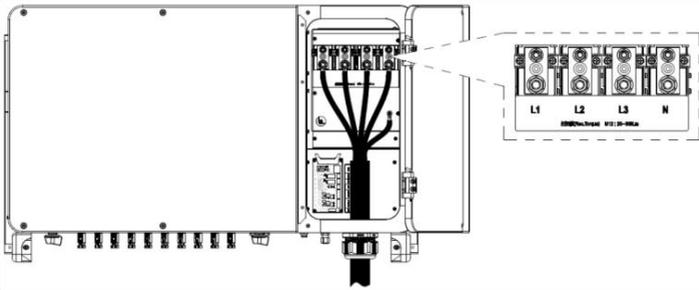
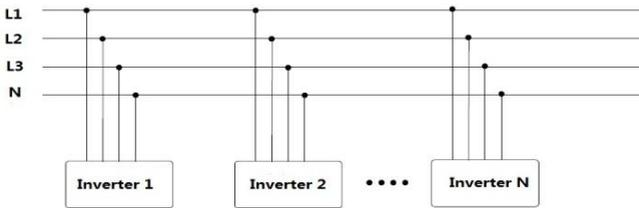

Fig 5.7 three-phase inverter grid access

5.4.3 Parallel connection requirements of multiple inverters

Connect multiple inverters to low-voltage three-phase grid directly. If the total capacity of the inverter exceeds 1.6MVA, contact our after-sale service staff.



Connect multiple inverters to the low-voltage side of the medium-voltage transformer and connect high-voltage side to the medium-voltage grid directly. If total capacity of the inverter exceeds 1.6MVA, contact our after-sale service staff. Meanwhile, the transformer should meet total output requirement of the inverter and has neutral point or externally-connected neutral conductor.

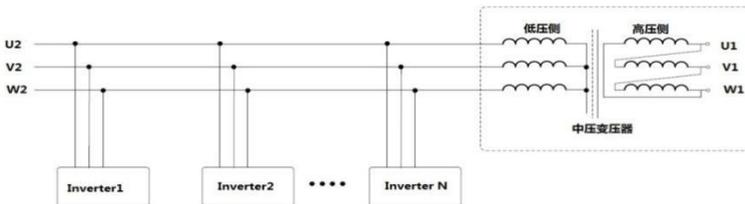

- It is recommended to use the transformer whose short-circuit impedance is no more than 7%

5.5 Connect the communication line

5.5.1 Interface description

The position of inverter communication terminal block in the chassis and its equipped terminals are shown in the figure below.

USB	Reserved	Reserved
RS485-1	Monitor communication interface or 485 communication	1- 485- 2- 485+ 3- 5V 4- Gnd
RS485-2	Anti-flow communication interface or 485 communication	1- 485- 2- 485+ 3- 5V 4- Gnd
CN1	Input dry contact	
DRY1	Output dry contact 1	
DRY2	Output dry contact 2	
DRM	Network port	

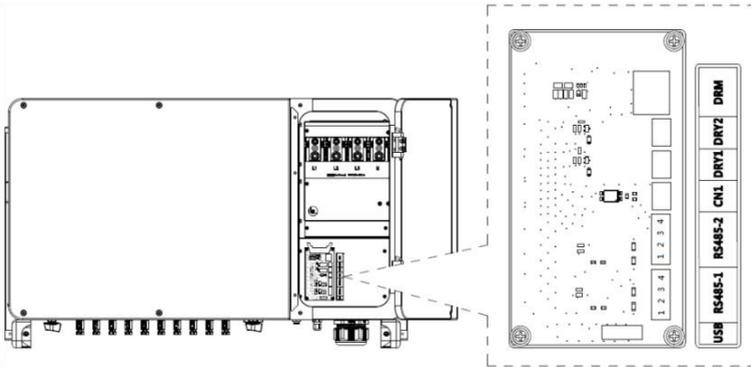

5.5.2 DRM interface description

(1) Open the AC terminal box and locate the DRM terminal;

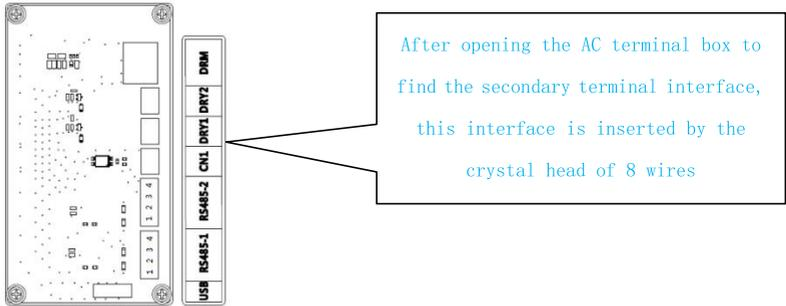

Cable arrangement order			
Pin 1	White and orange	Pin 2	Orange
Pin 3	White and green	Pin 4	Blue
Pin 5	White and blue	Pin 6	Green
Pin 7	White and blue	Pin 8	Brown

Figure 5.8 Crystal head cable arrangement

(2) Insert the crystal head into the DRM terminal;

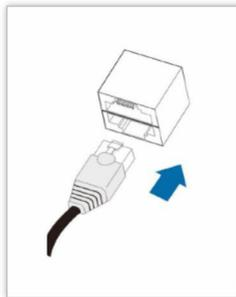

Figure 5.9 Crystal head access

(3) controller corresponding relay wiring and function realization;

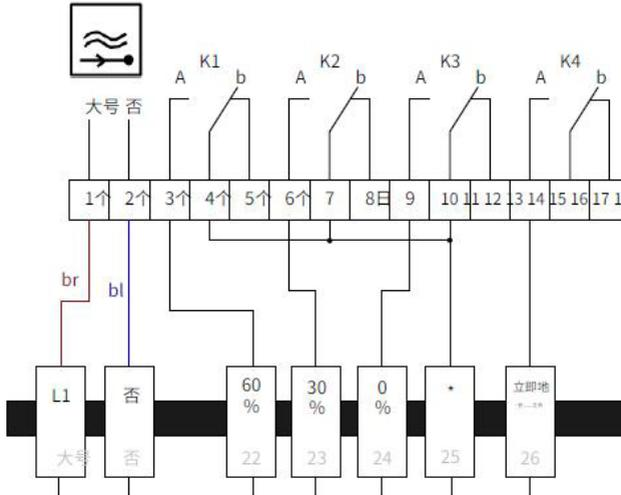

Figure 5.10 DRMS controller corresponding relay connection diagram

As in Figure 5.8 and Figure 5.10, operate as follows:

- (1) K1.K2.K3.K4 are hit to b to let the inverter output 100% active power;
- (2) Connect crystal head cable 1 to controller terminal 25;
- (3) Connect crystal head cable 7 to controller terminal 22, K2.K3.K4 to b, K1 to a to let the inverter output 60% power or power not more than 60%; (4) Connect crystal head cable 5 to controller terminal 22, K2.K3.K4 to b, K1 to a to let the inverter output 60% power or power not more than 60%;
- (4) Connect crystal head cable 5 to controller terminal 23, K1.K3.K4 to b and K2 to a to allow the inverter to output 30% power or no more than 30% power;
- (5) Connect crystal head cable 4 to controller terminal 24, K1.K2.K4 to b, K3 to a to make the inverter not output power or output power to 0;

Table 5.1 DRM terminal pin definition

Pin	Definition	Function
1	DRM1/5	100% output power
2	DRM2/6	No more than 60% of rated power
3	CN	
4	DRM3/7	No more than 30% of rated power
5	DRM4/8	No power generation, no output allowed
6	CN	
7	TX-/REF	Reference Voltage
8	TX+/COM	Reference Location

6 Running

This chapter introduces the related operations during the use of the inverter, which mainly involves pre-operation inspections, grid-connected operation of the inverter, inverter shutdown, and precautions for daily maintenance and repair of the inverter.

6.1 Inspection before running

The following items must be checked strictly before running the PV grid-connected inverter (including but not limited to the following items):

- (1) Confirm the installation site of the inverter meet requirements of section 4.2.2 to ensure convenient installation, disassemble, operation and inspection on the inverter;
- (2) Confirm the mechanical installation of the inverter meet requirements of section 5.3;
- (3) Confirm the electrical connection of the inverter meet the requirements of section 5.3;
- (4) Confirm all the switches are in "OFF" state;
- (5) Confirm the open-circuit voltage of PV component conforms to the parameter requirements of inverter DC side in appendix;
- (6) Confirm the electrical safety marks on the installation site is clear enough.



- In order to ensure a safe, normal and stable operation of the PV power generation system, all the newly installed, renovated and repaired PV grid-connected power generation system and its grid-connected inverter must undergo inspection before running.

6.2 Inverter grid-connected running

Start the inverter according to below steps to achieve grid-connected operation of the inverter:

Note

- It is a must to select the country to set grid-connected standard during the initial operation of the inverter, see details at section
- Keep the power-on state of the inverter for at least 30 minutes, and complete the charging of built-in clock battery of the inverter to ensure the clock can run normally!

- (1) Confirm the requirements in section 5.1 are satisfied
- (2) Turn on the breaker on inverter public grid AC side;
- (3) Turn on the integrated DC switch of the inverter;
- (4) Turn on the circuit switch on PV string DC input side;
- (5) Observe the LED indicator state of the inverter(For details, please see 2.6.1 and 2.6.2 LED indicator light.).

6.3 Inverter stop

When it is necessary to carry out power-off maintenance, inspection and fault elimination on the inverter, stop the inverter according to the following steps:

- (1) Disconnect the breaker on inverter public grid AC side;
- (2) Disconnect the integrated DC switch of the inverter;
- (3) Disconnect the circuit switch on PV string DC input side;
- (4) Wait for at least 5 minutes until the internal parts of the inverter are fully discharged, and complete the stop operation.

6.4 Daily maintenance and inspection

In solar PV grid-connected power generation system, the 3-phase PV grid-connected inverter can realize grid-connected power generation and stop/start operations automatically day and light in whatever seasons. In order to safeguard and prolong the service life of the inverter, it is necessary to carry out daily maintenance and inspection on the inverter besides using the inverter strictly according to this manual.

6.4.1 Periodic maintenance on the inverter

Item	Inspection method	Maintenance cycle
Save the inverter running data	Adopt monitoring software to read the inverter data in real time, and backup the data recorded by monitoring software periodically. Save the inverter running data, parameters and logs into the file, check the monitoring software and various parameter setup of the inverter.	Once per quarter
Inverter running state	Observe whether the inverter is installed firmly and whether it is damaged or deformed.. To listen whether there's any abnormal sound during inverter running. When the system is connected to the grid, check various variables. Check whether the heating of the inverter shell is normal, and use a thermal imager to monitor the heating of the system.	Once per half a year
Clean the inverter	Check the RH and dust around the inverter, and clean the inverter when necessary. Refer to section 6.4.2.	Once per half a year

Item	Inspection method	Maintenance cycle
Electrical connection	Check whether system cable connection and inverter terminal block are loosened, if yes, secure them again in the manner specified in section 4. Check whether the cable is damaged, and whether the cable skin touched by the metal surface is cut.	Once per half a year
Maintenance and replacement of cooling fan	For three-phase inverters, observe whether the air inlet/outlet is normal; check whether there are cracks on the fan leaf. Listen for abnormal noise during fan rotation. Clean the air inlet/outlet if necessary; If any abnormality occurred to the fan, replace the fan immediately . Refer to section 6.4.2.	Once per half a year
Safety function	Check the inverter LCD and stop function of the system. Simulate stop operation and check the stop signal communication. Check the warning marks and replace them if necessary.	Once per half a year

6.4.2 Maintenance guidance

Clean the inverter

The cleaning steps are listed below:

- (1) Disconnect the connection on input and output side;
- (2) Wait for ten minutes;
- (3) Clean the surface and air inlet/outlet of the inverter with soft brush or vacuum cleaner;
- (4) Repeat the operations in section 5.1;
- (5) Restart the inverter.

Fan maintenance

	<ul style="list-style-type: none"> ● Stop the inverter before maintenance operation, and disconnect all the power inputs of the inverter. ● Before carrying out maintenance operation, wait for at least 10 minutes until the internal capacitors of the inverter are fully discharged, ● The fan can be maintained and replaced by professional electricians only.
---	--

Step 1: Stop the inverter and disconnect the electrical connection.

- (1) Disconnect the input and output sides.
- (2) Turn the DC switch to the "OFF" position.
- (3) Wait at least 10 minutes.

(4) Disconnect all electrical connections from the bottom of the inverter.

Step 2: Remove the right side cover of the fan.

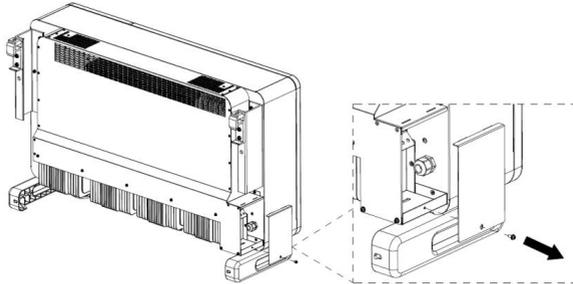

Step 3: disconnect the fan power connector and loosen the screw on the fan rack.

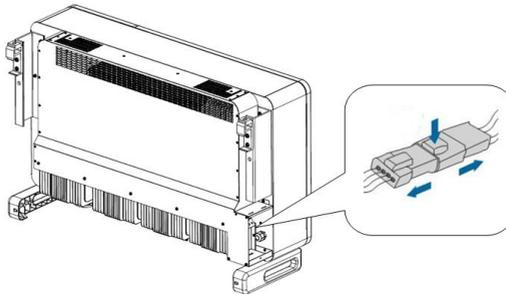

Step 4: Remove the screw fixed the fan tray and pull the fan tray out.

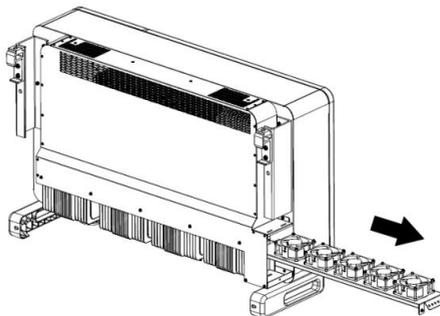

Step 5: use a soft brush or vacuum cleaner to clean the fan. If the fan is damaged, follow step 6.

Step 6: If the fan is damaged, remove the damaged fan and install a good fan to the original position.

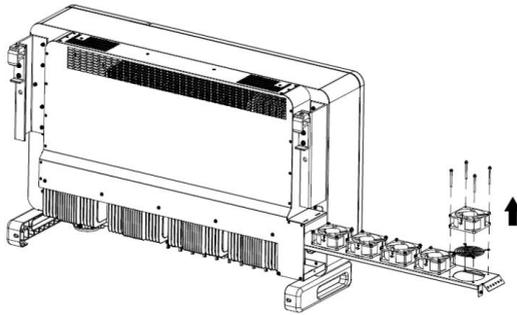

Step 7: install the fan tray back to the inverter in reverse order and restart the inverter.

Note

- Once the inverter stops due to an alarm, it is forbidden to start the machine immediately. The cause should be identified and all faults must be eliminated before starting up. Inspections should be carried out in strict accordance with the procedures in Section 5.4.

7 Fault isolation

This chapter mainly describes fault alarms and fault codes for figuring out the inverter fault quickly.

Table 7-1 Inverter fault code

Number	Fault types	Fault main code	Fault subcode	Fault information	Display information
1	BUS voltage failure	03	01	BUS voltage Low	03-01
			02	BUS voltage high	03-02
			03	BUS voltage imbalance	03-03
			04	Hardware BUS voltage high	03-04
2	Flow fault	05	01	Inverter hardware overcurrent	05-01
			02	Inverter software overcurrent	05-02
			03	The BOOST hardware overcurrent	05-03
			04	The BOOST software overcurrent	05-04
3	Thermal failure	06	01	The inverter temperature thermal	06-01
			02	The BOOST thermal	06-02
			03	The radiator thermal	06-03
			04	The environmental thermal	06-04
			05	Buck Boost temperature anomaly	06-05
			06	NTC open circuit	06-06
4	Insulation detection fault	07	01	Insulation detection fault	07-01
5	Drive failure	08	01	Drive failure	08-01
6	Communication failure	09	01	Main DSP receiving ARM communication fault	09-01
			02	ARM receiving Main DSP communication fault	09-02
			03	Secondary DSP receiving ARM communication fault	09-03
			04	ARM receiving secondary DSP communication fault	09-04
			05	Master-slave chip communication failure -master chip failure	09-05

Number	Fault types	Fault main code	Fault subcode	Fault information	Display information
			06	Master-slave chip communication failure - slave chip failure	09-06
			07	DSP and AFCI communication failure	09-07
7	Leakage current fault	10	01	Static leakage current is high	10-01
			02	30 mA mutation of failure	10-02
			03	60 mA mutation of failure	10-03
			04	150 mA mutation of failure	10-04
8	Relay failure	11	01	Relay open	11-01
			02	Relay short	11-02
			03	Relay self-test abnormality	11-03
9	Internal fan failure	12	01	Internal fans fault	12-01
10	DCI fault	14	01	DCI R phase failure	14-01
			02	DCI S phase failure	14-02
			03	DCI Tphase failure	14-03
11	PID fault	15	01	PID BUS voltage high	15-01
12	Consistency of failure	19	01	AC voltage test	19-01
			02	BUS voltage detecting inconsistencies	19-02
			03	ISO voltage detecting inconsistencies	19-03
			04	PV voltage detecting inconsistencies	19-04
			05	GFCI inconsistent	19-05
			06	Abnormal BUS voltage sampling	19-06
			07	Abnormal PV current sampling	19-07
13	Mains voltage fault	31	01	Grid undervoltage level 1	31-01
			02	Grid overvoltage level 1	31-02
			03	No grid voltage	31-03
			04	Grid undervoltage level 2	31-04
			05	Grid overvoltage level 2	31-05
			06	Undervoltage during grid power startup	31-08

Number	Fault types	Fault main code	Fault subcode	Fault information	Display information
			07	Overvoltage during grid power startup	31-07
			08	Interrupt transient overvoltage	31-08
			09	Island overvoltage	31-09
			10	Voltage oscillation in the power grid	31-10
			11	Grid undervoltage level 3	31-11
			12	Grid voltage phase-locked fault	31-12
14	Mains frequency fault	33	01	Grid underfrequency level 1	33-01
			02	Grid overfrequency1 order	33-02
			03	Grid underfrequency level 2	33-04
			04	Grid overfrequency 2 order	33-04
			05	Underfrequency of grid power startup	33-05
			06	Overfrequency of grid power startup	33-06
			07	Frequency self-test failed	33-07
15	Model recognition malfunction	36	01	Model recognition malfunction	36-01
16	Shutdown	37	01	Shutdown instructions	37-01
			02	Maintenance	37-02
17	AFCI fault	38	01	String 1 fault	38-01
18	Leakage current self-checking of failure	43	01	Leakage current sensor fault	43-01
19	Auxiliary power failure	45	01	Auxiliary power off	45-01

Table 7-2 inverter alarm code

Number	Alarm types	Alarm master code	alarm subcode	alarm information	Display information
1	Fan speed is low	01	01	Fan1	01-01
			02	Fan2	01-02
			03	Fan3	01-03
			04	Fan4	01-04
			05	Fan5	01-05
			06	Fan6	01-06
			07	Internal fan 1	01-07
			08	Internal fan 2	01-08
			09	Fan9	01-09
			10	Fan10	01-10
2	Lightning protector	02	01	DC Lightning protector	02-01
			02	AC Lightning protector	02-02
3	String current	04	01	A-phase meter abnormal	04-01
			02	B-phase meter abnormal	04-02
			04	C-phase meter abnormal	04-04
			08	Abnormal communication of meter	04-08
			16	CT wiring abnormality	04-16
			32	Yada meter recognition abnormality	04-32
4	Abnormal fuse	08	01	Abnormal fuse	08-01

If any problem, please contact with the supplier and provide following information:

- Model of the inverter: _____;
- Serial No. of the inverter: _____;
- System version:
——version 1: _____;
——version 2: _____;
——MCU software version: _____;
- Fault code: _____;
- Fault description _____

8 Appendix

Table 8-1 Technical parameters of three-phase PV grid-connected inverter

Model		MGSI-100K-03P3		MGSI-110K-03P3	
DC	Max DC voltage (V)	1100		1100	
	Starting voltage (V)	250		250	
	MPPT voltage range (V)	180~1000		180~1000	
	DC input voltage range during rated power (V)	530~850		530~850	
	MPPT number/number of connectable strings per group	9/2		10/2	
	Max DC power (W)	150000		150000	
	Max input current (A)× MPPT number	26×9		26×10	
	Every road MPPT photovoltaic array maximum short-circuit current (A)	40		40	
AC	Max output power (W)	100000		110000	
	Rated voltage and frequency range (V)	230/400Vac, 3L+N+PE/3L+PE, 50/60Hz ± 5HZ (可调)			
	Max AC output current (A)	144.3	158.8		
	Power factor	-0.8~+0.8 (adjustable)			
	Harmonic wave distortion	< 3% (at rated power)			
System	Cooling mode	Intelligent air cooling			
	Max efficiency	98.70%			
	Euro efficiency	98.30%			
	MPPT efficiency	99.90%			
	Protection level	IP66			
	Power consumption at nighttime	< 1W			
	Protective class	I			
	Overvoltage category	AC: III, PV: II			
	inverter topology	Non-isolated			
	Pollution degree	3			
	Ambient temperature	(-30℃~+60℃) . auto derating is required if the ambient temperature exceeds 45℃			
	RH	4~100%.condensation			
	Max altitude (m)	≤4000, derating is required if the altitude exceeds 3000m			
	Display	LED, Bluetooth+APP			
	System language	English, Chinese, Germany, Dutch			
	Communication mode	RS485/WiFi/4G/GPRS			
DC terminal	BC03A/ BC03B				
Installation mode	Wall installation				
Protection function	Input overvoltage protection, input overcurrent protection, DC insulation monitoring, DC monitoring, grounding fault current monitoring, grid monitoring, islanding protection, short-circuit protection and overheat protection, etc.				