

HYBRID INVERTER THREE PHASE

User Manual

4/5/6/8/10/12kW-25A

10/12/15/20kW-40A

— ENGLISH VERSION —

CONTENTS

1	About This Manual	5
	1.1 How To Use This Manual.....	5
	1.2 Target Groups	5
	1.3 Symbols	5
2	Safety Instructions	7
	2.1 Safety Notes	7
	2.2 Statement	7
3	Product Description	9
	3.1 System Introduction	9
	3.2 Product Introduction	10
	3.3 Symbols On the Inverter.....	12
	3.4 Operation Modes	13
	3.5 Back-Up and Off-Grid Output	18
	3.6 Unpacking and Storage	19
4	Installation	21
	4.1 Location	21
	4.2 Mounting the Inverter	23
5	Electrical Connection	26
	5.1 Electrical Wiring Diagram	27
	5.2 AC Connection	30
	5.3 Monitoring Device Installation	33
	5.4 Meter and CT Connection	34
	5.5 Communication Connection	35
	5.6 PV String Connection	47
	5.7 Power Cable of the Battery Connection	52
6	Commissioning	55
	6.1 App Preparation	55
	6.2 Inspection Before Commissioning.....	55
	6.3 Commissioning Procedure	55
	6.4 Stop the Inverter	56
7	Screen Operation	57
	7.1 Main Window.....	57
	7.2 General Setting	58

CONTENTS

7.3 Advanced Setting	60
7.4 Country Code (Safety Code) Setting	63
7.5 Auto-Test	63
7.6 Reactive Power	65
8 Monitoring	66
8.1 Monitoring Device	68
8.2 Cloud monitoring App	69
8.3 Local configuration App	69
9 Troubleshooting	68
9.1 Error Message	70
9.2 Inverter Maintenance	75
9.3 Battery Maintenance	76
10 Appendix	75
10.1 Technical Parameters	77

1 About This Manual

This manual is an integral part of 4~20K three-phase high-voltage hybrid inverters (hereinafter referred to as the inverter). It mainly introduces the assembly, installation, electrical connection, debugging, maintenance and troubleshooting of the products.

All or part of the products, services or features described in this document may not be within the scope of purchase. This document serves only as a guide to use, and all statements, information and recommendations in this document do not constitute any express or implied guarantee.

1.1 How To Use This Manual

Before installing and using inverters, please read this manual carefully, understand the safety information and be familiar with the functions and characteristics of inverters.

1.2 Target Groups

This manual is applicable to electrical installers with professional qualifications and end-users, who should have the following skills:

- ① Training for installation and commissioning of the electrical system, as well as dealing with hazards.
- ② Knowledge of the manual and other related documents.
- ③ Knowledge of the local regulations and directives.

1.3 Symbols

Important instructions contained in this manual should be followed during installation, operation and maintenance of the inverter. They will be highlighted by the following symbols.



Indicates a hazard with a high level of risk that, if not avoided, will result in death or serious injury.



Indicates a hazard with a medium level of risk that, if not avoided, could result in death or serious injury.



Indicates a hazard with a low level of risk that, if not avoided, could result in minor or moderate injury.

4-20kW three phase hybrid inverter



Indicates a situation that, if not avoided, could result in equipment or property damage, data loss, equipment performance degradation.



Indicates additional information, emphasized contents or tips that may be helpful, e.g., to help you solve problems or save time.

2 Safety Instructions

2.1 Safety Notes

- ① Before installation, please read this manual carefully and follow the instructions in this manual strictly.
- ② Installers need to undergo professional training or obtain electrical related professional qualification certificates.
- ③ When installing, do not open the front cover of the inverter. Apart from performing work at the wiring terminal (as instructed in this manual), touching or changing components without authorization may cause injury to people, damage to inverters and annulment of the warranty.
- ④ All electrical installations must conform to local electrical safety standards.
- ⑤ If the inverter needs maintenance, please contact the local designated personnel for system installation and maintenance.
- ⑥ To use this inverter for power generation needs the permission of the local power supply authority.
- ⑦ The temperature of some parts of the inverter may exceed 60° C during operation. To avoid being burnt do not touch the inverter during operation. Let it cool before touching it.
- ⑧ When exposed to sunlight, the PV array generates dangerous high DC voltage. Please operate according to our instructions, or it will result in danger to life.
- ⑨ When wiring the lithium battery terminals, please disconnect the breaker or switch of the lithium battery in case of a physical injury caused by the high voltage.

2.2 Statement

Manufacturer have the right not to undertake quality assurance in any of the following circumstances:

- ① Damages caused by improper transportation.
- ② Damages caused by incorrect storage, installation or use.
- ③ Damages caused by installation and use of equipment by non-professionals or untrained personnel.
- ④ Damages caused by failure to comply with the instructions and safety warnings in this document.
- ⑤ Damages of running in an environment that does not meet the requirements stated in this document.
- ⑥ Damages caused by operation beyond the parameters specified in applicable technical specifications.

4-20kW three phase hybrid inverter

- ⑦ Damages caused by unauthorized disassembly, alteration of products or modification of software codes.
- ⑧ Damages caused by abnormal natural environment (force majeure, such as lightning, earthquake, fire, storm, etc.).
- ⑨ Any damages caused by the process of installation and operation which don't follow the local standards and regulations.
- ⑩ Products beyond the warranty period.

3 Product Description

3.1 System Introduction

The hybrid solar system is usually composed of the PV array, hybrid inverter, lithium battery, loads and power grid.

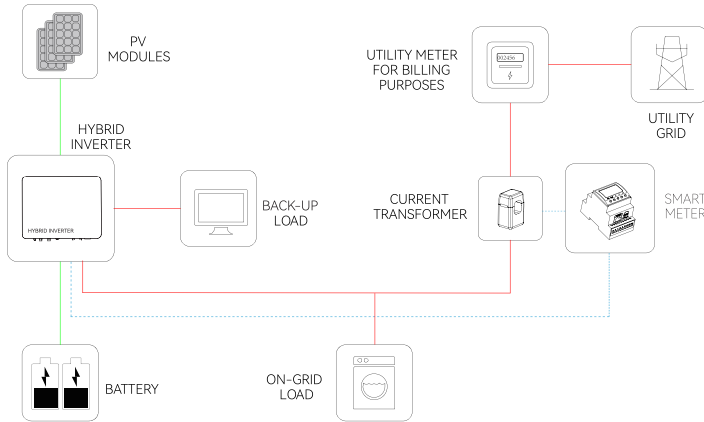

Figure 3-1 Schematic diagram of hybrid system



NOTICE

The system is not suitable for supplying life-sustaining medical devices. It cannot guarantee backup power in all circumstances.

The applicable grid types for the 4~20K series are TN-S, TN-C, TN-C-S and TT. When applied to the TT grid, the voltage of N to PE suggests less than 30V.

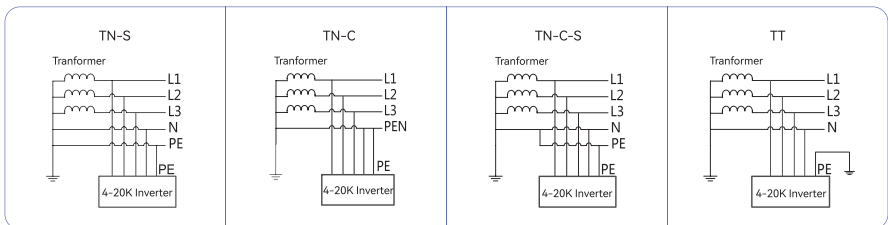

Figure 3-2 Applicable grid types

4-20kW three phase hybrid inverter

3.2 Product Introduction

The 4-20kW 3Phase hybrid Inverter is also known as hybrid inverter or storage inverter, which is mainly used to combine the PV array, lithium battery, loads and power grid to realize intelligent power management and dispatching.

3.2.1 Models

The 4-20kW 3Phase hybrid Inverter includes 10 models which are listed below:

4kW-25A,5kW-25A,6kW-25A,8kW-25,10kW-25A,12kW-25A,10kW-40A,12kW-40A,15kW-40A,20kW-40A

Regulation: Rated output power

XX kW - XX A

Charging/Discharge Current

3.2.2 Appearance

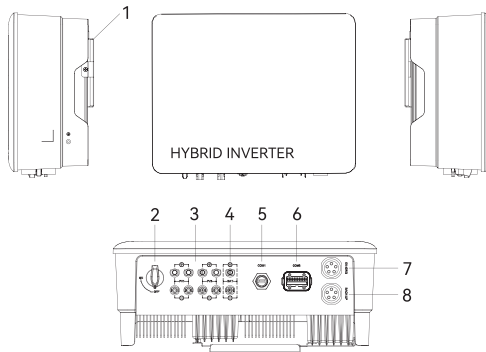

Figure 3-3 Inverter Appearance







Wiring terminals are at the bottom of the inverter, as shown in the table below.

Item	Terminal	Note
1	Hanger	Used to hang the inverter on the wall-mounting bracket.
2	DC switch	Used to safely disconnect the DC circuit.
3	DC input terminal	PV connector
4	Battery input terminal	Battery connector
5	COM1 port	WiFi/LAN/4G module connector
6	COM2 port	Multi-function Connector (Meter/BMS/RS485/DRED)
7	On-grid output terminal	Used for On-grid output cable connection
8	Back-up output terminal	Used for Back-up output cable connection

▼ 3.2.3 Indicator

Item	Indicator	Status		Description
1	Power and Alarm Indicator	Off		No power.
		Green	Quick flashing	Inverter entered self-test status.
			Slow flashing	Inverter entered waiting status.
			Breathe flashing	Inverter works normal.
		Orange	Breathe flashing	Low battery warning, the battery power is about to reach the SOC protection value.
Red	Always on	An alarm or fault is detected, view the fault info on the display.		
2	Grid Indicator	Off		Grid lost.
		Slow flashing		Inverter detected grid but not running in on-grid mode.
		Always on		Inverter works in on-grid mode.
3	Communication Indicator	Green	Always on	The inverter communication is running normally.
		Green	Flashing	The inverter communicates with EMS or Master inverter through RS485 or CAN.
		Orange	Always on	The inverter isn't communicating with smart meter.
		Red	Always on	The inverter isn't communicating with the BMS.
4	Display	Display off to save power, press the button to wake up the display.		
5	Button	Switch display information and set parameters by short press or long press.		

3.3 Symbols On the Inverter

Symbol	Description
	<p>To avoid the potential effects on the environment and human health as a result of the presence of hazardous substances in electrical and electronic equipment, end-users of electrical and electronic equipment should understand the meaning of the crossed-out wheeled bin symbol. Do not dispose of WEEE as unsorted municipal waste and have to collect such WEEE separately.</p>
	<p>Please read the instructions carefully before installation.</p>
	<p>Do not touch any internal parts of the inverter within 10 minutes of disconnecting the power, battery and PV input.</p>
	<p>CE mark, the inverter complies with the requirements of the applicable CE guidelines.</p>
	<p>Danger. Risk of electric shock!</p>
	<p>The surface is hot during operation and do not touch.</p>
	<p>Additional grounding point.</p>

3.4 Operation Modes

Hybrid inverter has the following basic operation modes and you can configure the operation mode as per your preference in the App.

General Mode

In this working mode, when the power from the PV array is sufficient, PV power will supply the loads, battery, and grid in the order of loads first, battery second, and grid last.

(You can set the power to the grid to 0W when the local grid doesn't allow inverter power to feed to the grid).

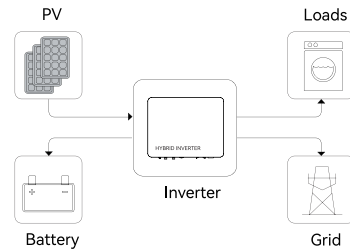

When the PV power is insufficient, the battery will discharge to supply loads, and the grid will join in if the battery is not enough to supply loads.

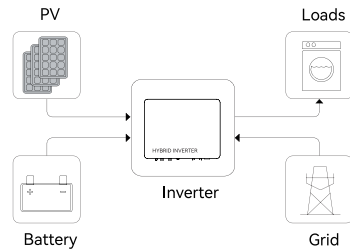

4-20kW three phase hybrid inverter

Peak load Shifting (Load Shifting)

Set the maximum power P_{max} (kVA) contracted with the grid.

When the load consumption is less than the P_{max} , the PV will charge the battery first, and the grid supplies the load. When the battery is full, PV will supply the load together with the grid, but the battery doesn't.

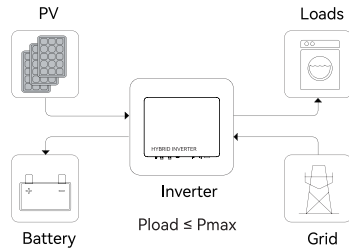

When the load consumption exceeds the P_{max} , the inverter will take power from the battery and PV to supply power to the load to compensate for the power that exceeds the P_{max} .

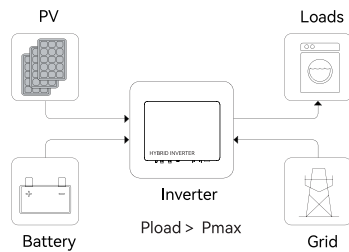

*To realize the "Peak load Shifting" function, the load power that exceeded P_{max} has to be within the inverter max output power, otherwise, the inverter will only output the max power which allowed.

UPS Mode

In this working mode, the inverter will use the power from PV or grid to charge the battery until it is fully charged, and as long as the grid is there, the battery won't discharge.

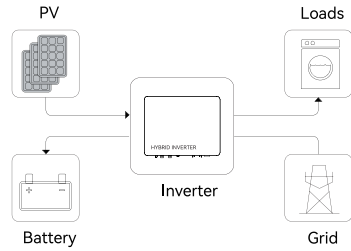

When the grid fails, power from PV and battery will supply loads connected on the back-up side (UPS).

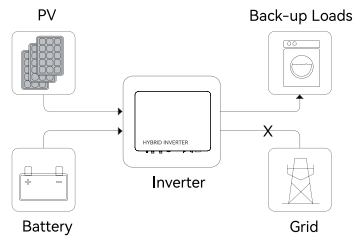

4-20kW three phase hybrid inverter

Economic Mode

In this working mode, you can set charge/discharge power and time in the App, inverter will use the power from PV or grid (whether to use can be set in the App) to charge the battery in the predetermined period.

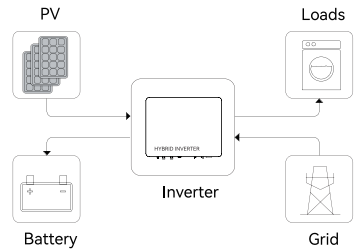

Inverter will use power from PV and battery to supply loads in the predetermined period and the insufficient part will be supplied by the grid.

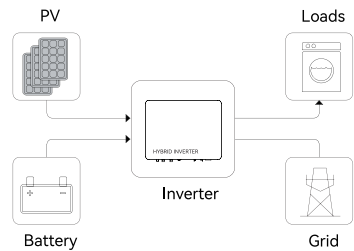

Off-grid Mode

In the purely off-grid mode, power from PV will supply the back-up loads first and then charge the battery if there's surplus power.

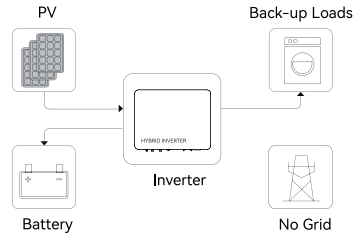

When the power from PV isn't enough, the battery will discharge to supply back-up loads together with PV.

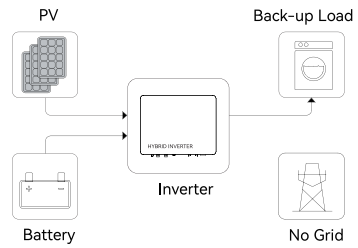

3.5 Back-Up and Off-Grid Output

Normally, the Back-Up switching time is less than 10ms. However, some external factors may cause the system to fail on switching to Back-Up mode. Therefore, the conditions for using the Back-Up function smoothly are as follows for your awareness.

- ① Do not connect loads that are dependent on a stable energy supply for a reliable operation.
- ② Do not connect the loads whose total capacity is greater than the maximum Back-Up capacity.
- ③ Do not connect the loads that may cause very high start-up current surges, such as non-frequency conversion air conditioning, vacuum cleaner or half-wave loads such as hair dryer, heat gun, hammer drill.
- ④ Due to the condition of the battery itself, battery current might be limited by some factors, including but not limited to the temperature and weather.

4-20kW 3Phase hybrid inverter overloading ability in off-grid work mode describes as follows:

Off-grid Overloading Ability Illustration					
Status	Mode	Phase 1	Phase 2	Phase 3	Duration
Off-grid	Balance Output Mode	1.1times	1.1times	1.1times	Continuous
		2times	2times	2times	60s
	Unbalance Output Mode	1.25times*	1.25times*	1.25times*	Continuous

The multiples above are calculated based on rated output power.

20kW-40A instantaneous max output power is 25kW.

*Only one of the three phases can reach up to 1.25times, and the other two phases should be less than 1.1times.

The inverter will restart in case of overload protection. The time required for restarting will increase (5 min at most) if overload protection repeats. Try to reduce Back-Up load power within maximum limitation or remove the loads which may cause very high start-up current surges.

3.6 Unpacking and Storage

The device is thoroughly tested and strictly inspected before delivery. Nonetheless, damage may still occur during shipping. For this reason, please conduct a thorough inspection after receiving the device.

Contact us or the transport company in case of any damage or incompleteness, and provide photos to facilitate services.

▼ 3.6.1 Packing List

The package of the inverter includes the following accessories. Please check whether the accessories in the packing box are complete when receiving the goods.

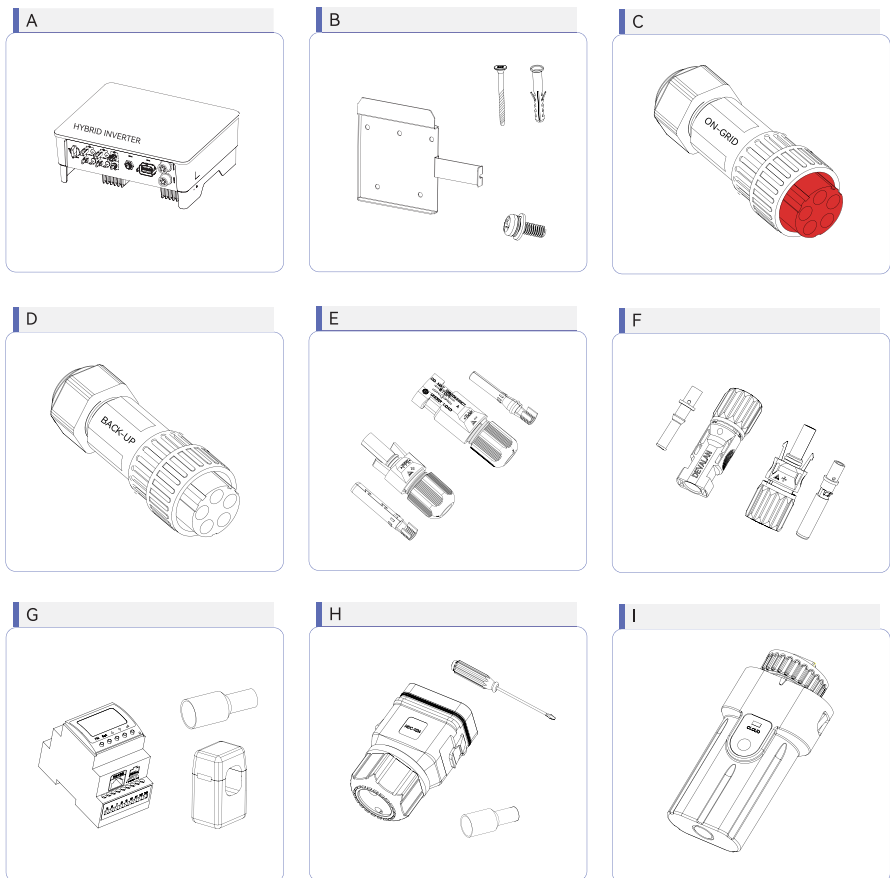

4-20kW three phase hybrid inverter

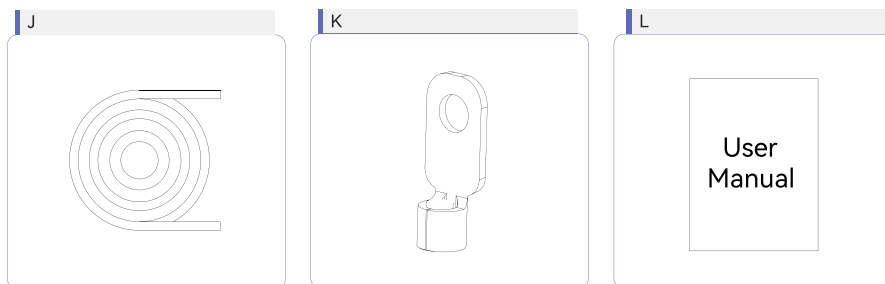

Figure 3-4 Packing list

Item	Name and Quantity	Note
A	Inverter (1pcs)	
B	Wall-mounting bracket (1pcs), Expansion plug set (5pcs), M5 screws (1pcs)	
C	On-grid connector set (1pcs)	Red
D	Back-up connector set (1pcs)	Black
E	PV terminal (4-12kW-25A 2 pairs / 10-20kW-40A 4 pairs)	Black,U-profile pin
F	Battery terminal (Enclosure:1pair,Metal core:4-12kW-25A 1 pair / 10-20kW-40A 2 pairs)	Blue,O-profile pin
G	Meter with 3 CTs (1pcs)	
H	COM2 connector set (1pcs)	
I	Monitoring device (1pcs)	
J	10m meter communication cable (1pcs), 3m battery communication cable (1pcs)	
K	PE terminal(1pcs)	
L	User guide	

▼ 3.6.2 Inverter Storage

- ① Do not dispose of the original packing case. It is recommended to store the device in the original packing case when the device is decommissioned.
- ② The storage temperature and humidity should be in the range of -30°C and $+60^{\circ}\text{C}$, and less than 90%, respectively.
- ③ If a batch of inverters needs to be stored, the height of each pile should be no more than 6 levels.

4 Installation

4.1 Location

The hybrid Inverters are designed with IP65 protection enclosure for indoor and outdoor installations. When selecting an inverter installation location, the following factors should be considered:

- ① The wall on which the inverters mounted must be able to withstand the weight of the inverter.
- ② The inverter needs to be installed in a well-ventilated environment.
- ③ Do not expose the inverter directly to strong sunlight to prevent excessive temperature operation. The inverter should be installed in a place with shelter to prevent direct exposure to sunlight and rain.
- ④ Install the inverter at eye level for easy inspection of screen data and further maintenance.
- ⑤ The ambient temperature of the inverter installation location should be between -30°C and 60°C .
- ⑥ The surface temperature of the inverter may reach up to 75°C . To avoid risk of burns, do not touch the inverter while it's operating and inverter must be installed out of reaching of children.

▼ 4.1.1 Installation location

Select an optimal mounting location for safe operation, long service life and expected performance.

- ① The inverter with protection rating IP65 can be installed both indoors and outdoors.
- ② Install the inverter at a place convenient for electrical connection, operation, and maintenance.

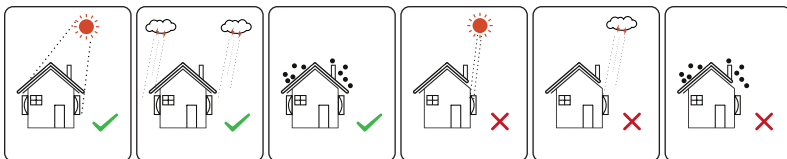

Figure 4-1 Recommended installation location



Do not put flammable and explosive articles around the inverter.

4-20kW three phase hybrid inverter

4.1.2 Installation Spacing

Reserve enough clearance around the inverter to ensure sufficient space for heat dissipation.

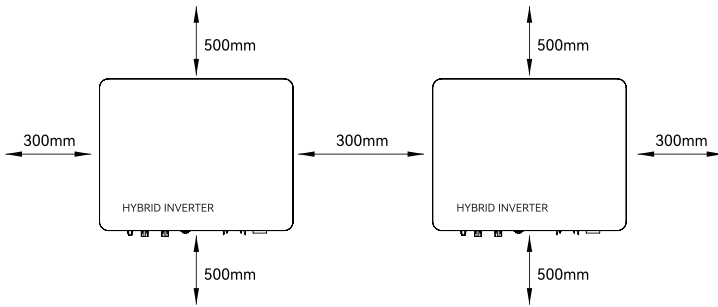

Figure 4-2 Recommended installation spacing

4.1.3 Installation Angle

Install the inverter vertically. Never install the inverter horizontally, or at forward/backward tilted, or upside down.

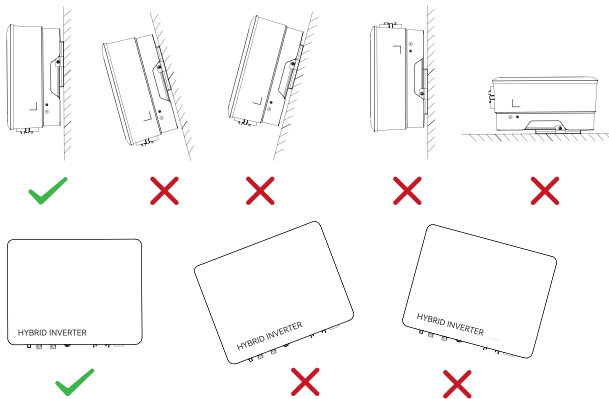

Figure 4-3 Permitted and prohibited mounting positions

4.2 Mounting the Inverter

4.2.1 Wall Bracket Installation

Dimensions of wall bracket (mm)

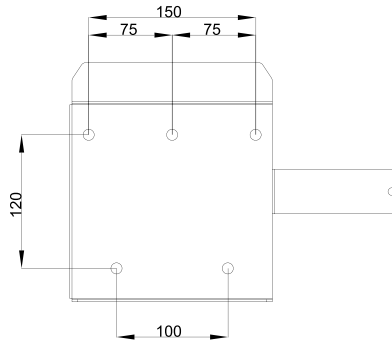

Figure 4-4 Dimensions of wall bracket

- ① Use the wall bracket as the template to mark the position of 5 holes on the wall.

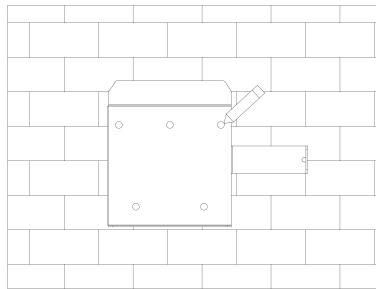

Figure 4-5 Marking hole position using installation bracket

- ② Use an electrical driller with 10mm diameter bit to drill 5 holes in the wall with 80mm depth.



Before drilling, make sure to avoid any buried water tube and electric wires in the wall.

- ③ Insert the expansion tubes into the holes and tighten them, then fix the bracket onto the wall with expansion screws by using a cross screwdriver.

4-20kW three phase hybrid inverter

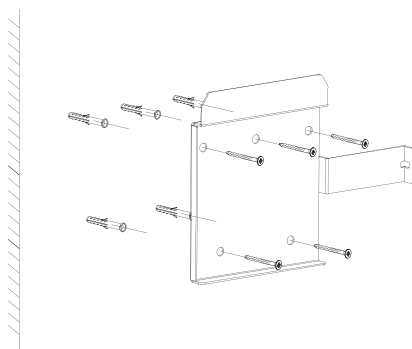

Figure 4-6 Fixing the wall bracket

▼ 4.2.2 Mounting the Inverter

Lift the inverter, hang the back rail on the fixed wall bracket carefully. Secure the inverter with M5 screws.

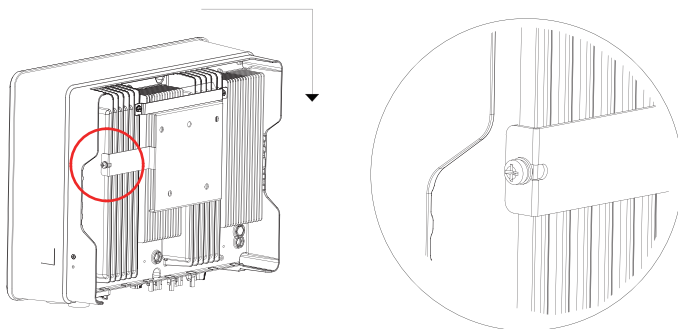

Figure 4-7 Mounting the inverter

▼ 4.2.3 External Ground Connection

Connect the inverter and ground bar through PE wire to achieve the purpose of grounding protection. Please always remember wiring the PE wire before wiring other wires.



Do not connect the N-wire as a protective ground wire to the inverter casing. Otherwise, it may cause electric shock.



Reliable grounding is good for resisting surge voltage shock and improving EMI performance.

Inverters must be well-grounded.

For a system with only one inverter, just ground the PE cable.

For a multi-inverter system, all inverters PE wire need to be connected to the same grounding copper bar to ensure equipotential bonding.

Ground terminal connection steps:

- ① The external grounding terminal is located at the lower right side of the inverter.
- ② Fix the grounding terminal to the PE wire with a proper tool and lock the grounding terminal to the grounding hole in the lower right side of the inverter.

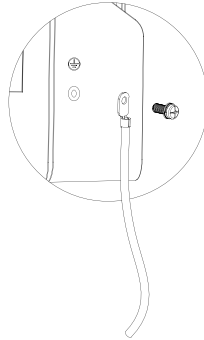

Figure 4-8 Grounding terminal connection

5 Electrical Connection



A high voltage in the conductive part of the inverter may cause an electric shock. When installing the inverter, make sure that the AC and DC sides of the inverter are completely de-energized.



Do not connect the N-wire as a protective ground wire to the inverter casing. Otherwise, it may cause electric shock.



Do not ground the positive or negative pole of the PV string, otherwise it will cause serious damage to the inverter.



Static may cause damage to the electronic components of the inverter. Anti- static measures should be taken during installation and maintenance.



Do not use other brands or other types of terminals other than the terminals in the accessory package. Manufacturer has the right to refuse all damages caused by the mixed-use of terminals.



Moisture and dust can damage the inverter, ensure the cable gland is securely tightened during installation. The warranty claim will be invalidated if the inverter is damaged as a result of a poorly connected cable connector.

5.1 Electrical Wiring Diagram

This diagram shows 4-20kW 3Phase hybrid Inverter wiring structure and composition, concerning the real project, the installation and wiring have to be in line with the local standards.

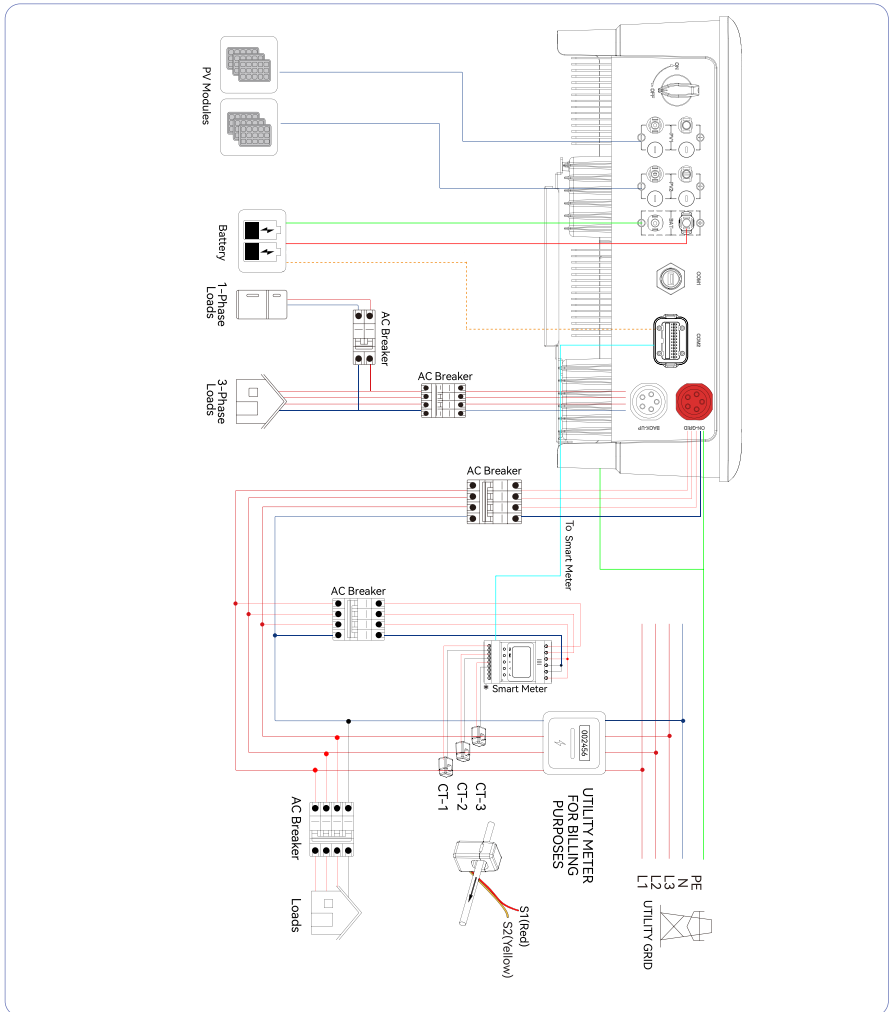

Figure 5-1 Electrical wiring diagram

*Smart Meter consists of ACR10R and SM. Define the cable connections for the meter based on the actual meter model and refer to Section 5.4. This cable diagram is for reference only.

4-20kW three phase hybrid inverter

Single inverter wiring diagram

This diagram is an example without special requirement on electrical wiring connection. Neutral line of AC supply can be isolated or switched.

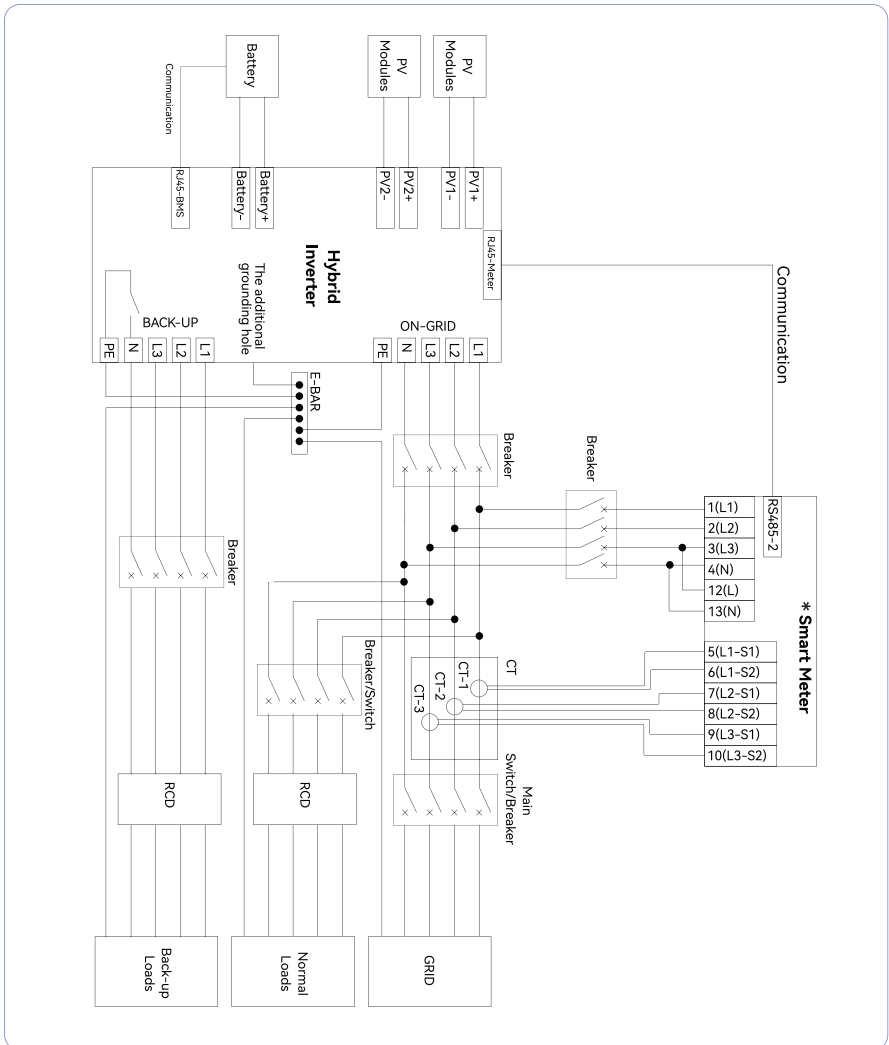

Figure 5-2 Standard wiring diagram

*Smart Meter consists of ACR10R and SM. Define the cable connections for the meter based on the actual meter model and refer to Section 5.4. This cable diagram is for reference only.
 12(L)*/13(N)*:Only ACR10R have those parts. 11(PE)*:Only SM have this part.

This diagram is an example for Australia and New Zealand. Neutral line of AC supply must not be isolated or switched, and the neutral line of GRID side and BACK-UP side must be connected together according to the wiring rules AS/NZS_3000. Otherwise, BACK-UP function will not work.

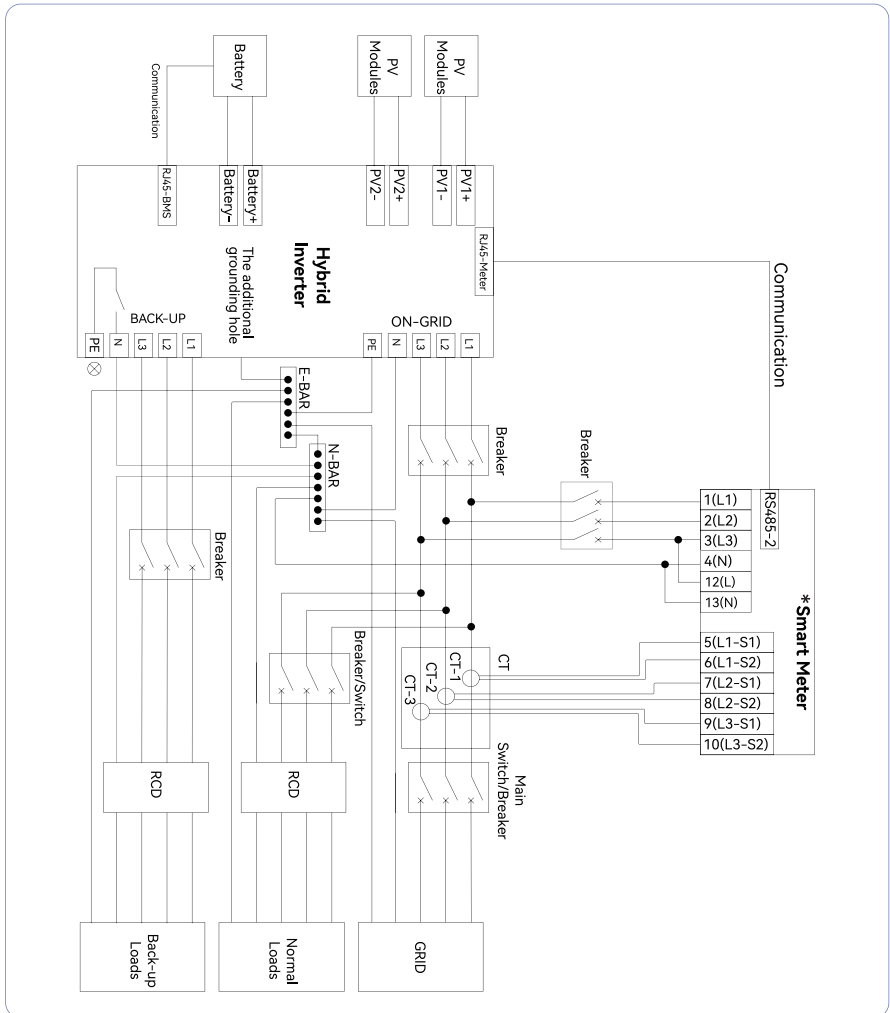

Figure 5-3 Australia wiring diagram

*Smart Meter consists of ACR10R and SM. Define the cable connections for the meter based on the actual meter model and refer to Section 5.4. This cable diagram is for reference only.
 12(L)*/13(N)*:Only ACR10R have those parts. 11(PE)* :Only SM have this part.

5.2 AC Connection

5.2.1 AC Side Requirements



- ① An independent AC breaker is required in both on-grid and back-up output side, and any loads cannot be connected with inverter directly.
- ② Before making the connection of AC cable, please confirm all DC & AC power source are disconnected from the inverter.
- ③ The 4~20K series three-phase high voltage hybrid inverter applies to the three-phase power grid with a voltage of 230/400V and a frequency of 50/60Hz.
- ④ Connect the inverter to the grid only after getting an approval from the local electric power company.

A three-phase AC breaker needs to be installed on the AC side of the hybrid inverter. To ensure that the hybrid inverter can safely disconnect itself from the power grid when an exception occurs, select a proper overcurrent protection device in compliance with local power distribution regulations and Max. input (output) current of hybrid inverter AC side. The allowable AC cable of wire diameter and cross-sectional area for hybrid inverter are as shown in the following:

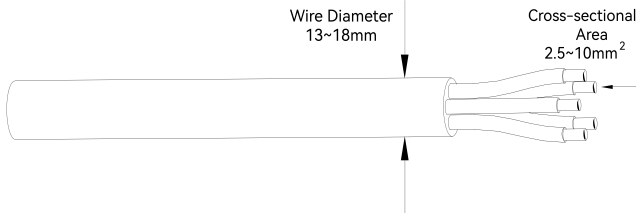

Figure 5-4



Determine whether an AC circuit breaker with greater overcurrent capacity is required based on actual conditions.

Residual Current Monitoring Device

With an integrated universal residual current monitoring device, the inverter will disconnect immediately from the mains once a fault current with a value exceeding the limit is detected.

However, if an external residual current device (RCD) is mandatory, the switch must be triggered at a residual current of 300 mA (recommended), or it can be set to other values according to local regulations. For example, in Australia, the inverter can use an additional 30mA (type A) RCD in installations.

▼ 5.2.2 Assembling the AC Connector

The AC terminal block is on the bottom side of the inverter.

- ① Take the AC connector out of the accessory bag and disassemble it.

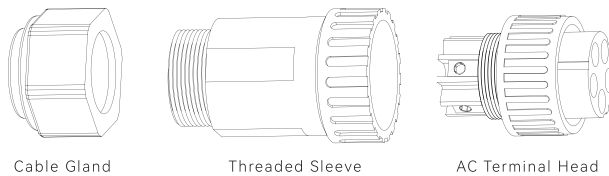

Figure 5-5

- ② According to the figure 5-4, select an appropriate cable, peel the insulation sleeve of AC cable off for 50mm, and peel off the end of 3L /PE / N wires for 8mm.



Figure 5-6

- ③ Insert the stripped end of the five wires into the appropriate hole of the terminal head. Please try to pull out the cable to make sure it is well connected.

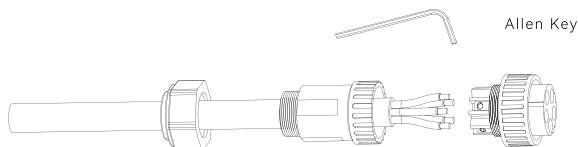

Figure 5-7

4-20kW three phase hybrid inverter



The cord end terminals must be locked tightly, and make sure it won't be loose after a long period of use.

- ④ According to the arrow direction push the threaded sleeve to make it connected with the AC terminal head and then rotate the cable gland clockwise to lock it.

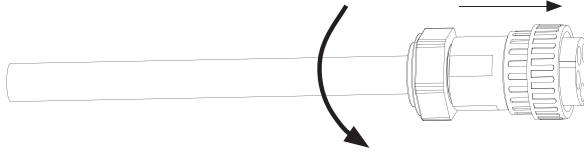

Figure 5-8

5.2.3 Installing the AC Connector



High voltage may be present in inverter!
Ensure all cables are voltage-free before electrical connection.
Do not connect the AC circuit breaker until all inverter electrical connections are completed.

Connect the AC connector to the inverter AC terminal, and rotate the AC connector buckle clockwise until its tight enough.

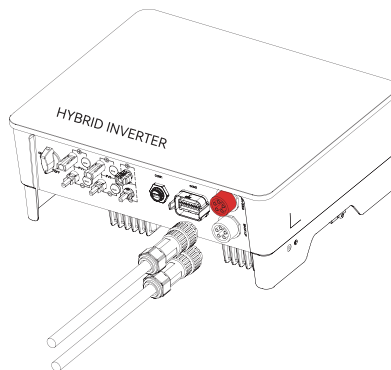

Figure 5-9



Please distinguish the on-grid and back-up port, and don't mix up the on-grid port and back-up port when making the connection.

5.3 Monitoring Device Installation

4-20kW 3Phase hybrid inverter supports WIFI, LAN, and 4G communication.

Plug the WIFI, LAN, or 4G module into the COM1 port in the bottom of inverter. A slight "click" sound during the installation represents that the assembly is in place.

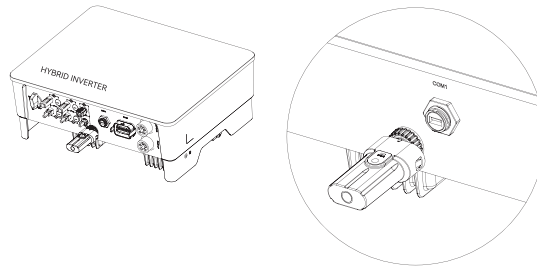

Figure 5-10 Monitoring device installation



Refer to “8 Monitoring” for more information.

5.4 Meter and CT Connection

The current Transformer, also called CT, is usually installed on the L wires between the house loads and the power grid.

The Meter can be installed in the AC combiner box or other places that are unable to be touched by children. CT cable with length of 2m, it's fixed and can't be extended.

The CTs have been connected to the Smart Meter when you received them, and you just need to follow the wiring diagram in the Meter to connect CT.

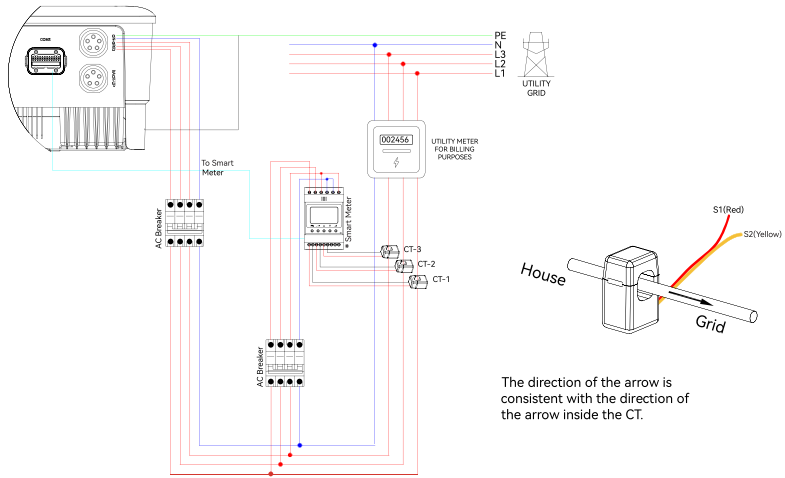

Figure 5-11



NOTICE

CT installation direction should strictly follow the instruction in the user manual, otherwise, the inverter may not be working normally.

The CT has to be corresponding with the port in the meter, and the connection between CT and Meter needs to be reliable, otherwise, the CT measurement accuracy may be affected.



NOTE

Please choose the appropriate CT size according to your needs.

Meter terminals definition as shown in table below:

No.	Definition		Function
	ACR10R	SM	
1	L1		L1/L2/L3/N connect to grid to detect power grid voltage
2	L2		
3	L3		
4	N		
5	L1-S1		To detect the CT current and direction
6	L1-S2		
7	L2-S1		
8	L2-S2		
9	L3-S1		
10	L3-S2		
11	/	PE	Ground connection
12	L	/	Power supplied from grid
13	N	/	
RS485	/	Reserve	Communicate with hybrid inverter
	RS485	RS485-2	
ANT	/	Reserve	
LAN	/	Reserve	
Type-C	/	Type-C	Specified Debug Interface. Do not use it by non-professionals

5.5 Communication Connection

All communication ports are in the multifunction communication Port at the bottom of inverter which including Meter port, CAN port, BMS port, EMS port, RLYOUT port, DRED port.

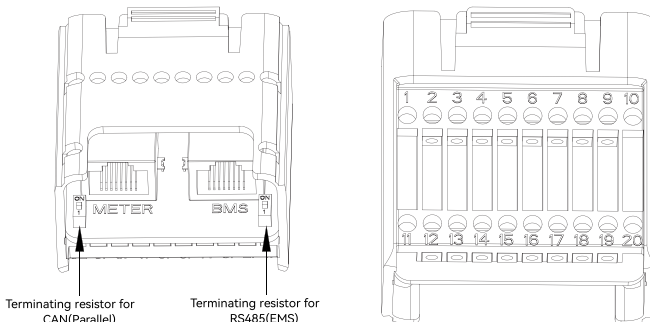

Figure 5-12

4-20kW three phase hybrid inverter

Pin	Definition	Function
METER (RJ45-1)	RS 485	Communicate with Meter
BMS (RJ45-1)	CAN	Communicate with BMS
1	COM	Multifunction Relay
2	NO (Normally Open)	
3	/	Reserved
4	/	Reserved
5	DRM4/8	DRED For Australia and New Zealand RCR For Germany and some other European countries
6	DRM3/7	
7	DRM2/6	
8	DRM1/5	
15	COM D/0	
16	REF D/0	
11	Emergency stop +	
12	Emergency stop -	
13	485 B1	EMS
14	485 A1	
17	CANL_P	CAN for parallel connection of inverters
18	CANH_P	
19	/	Reserved
20	/	Reserved

▼ 5.5.1 Assembling the Multi-com Connector

- ① Unscrew the swivel nut from the connector.

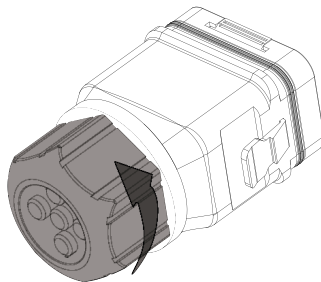

Figure 5-13

- ② Take out the terminal block.

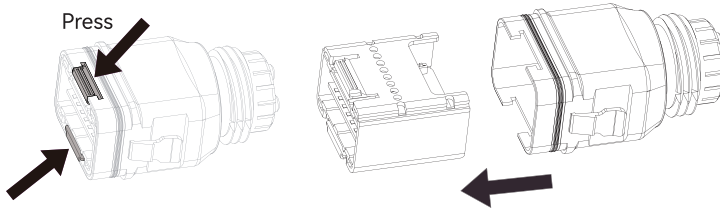

Figure 5-14

- ② Remove the seal and lead the cable through the cable gland.

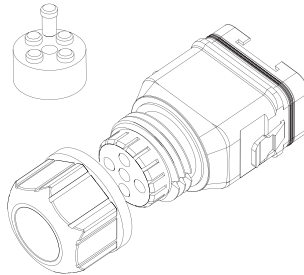

Figure 5-15

▼ 5.5.2 Connect the Meter And BMS Communication Cables



NOTE

The communication between meter/BMS and inverter is RJ45 interface cable.

- ① Thread the RJ45 plug of appropriate length through the swivel nut, and insert it into the open side of the rubber gasket.

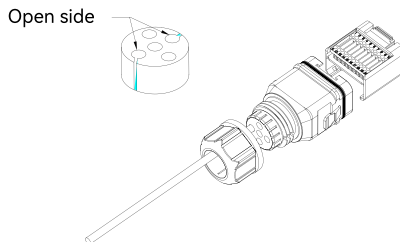

Figure 5-16

4-20kW three phase hybrid inverter

- ② Insert one side of the RJ45 plug into the RJ45 port of terminal block.

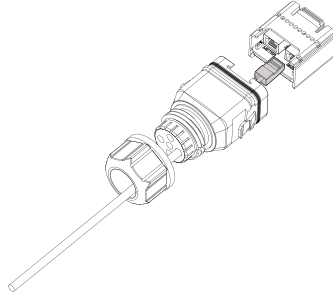

Figure 5-17

- ③ Insert another side of the communication cable into the meter RS485 port or BMS CAN port.

▼ 5.5.3 Connect Other Cables

- ① Thread the cable of appropriate length through the swivel nut and the housing. Remove the cable jacket and strip the wire insulation.

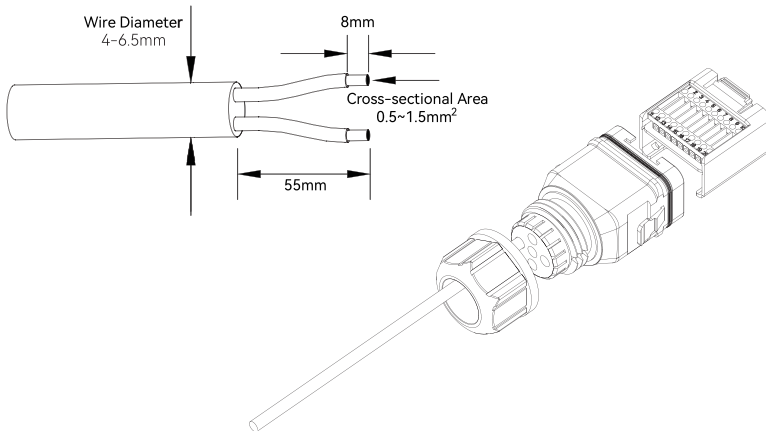

Figure 5-18

- ② (Optional) When using a multi-core multi-strand copper wire cable, connect the AC wire head to the cord end terminal (hand-tight). In case of single-strand copper wire, skip this step.

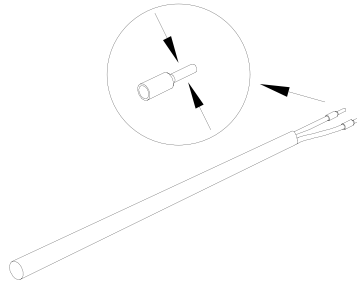

Figure 5-19

③ Fix all the wires to the terminal plug according to the assignment and tighten to a torque of $1.2\pm 0.1\text{N}\cdot\text{m}$ with a screwdriver.

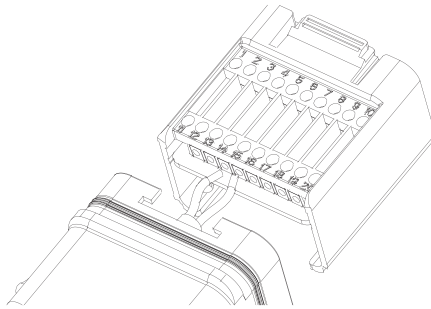

Figure 5-20

④ Pull the wires outward to check whether they are firmly installed. Insert the terminal block into the connector until it snaps into place with an audible click.

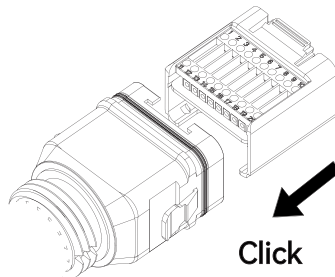

Figure 5-21

4-20kW three phase hybrid inverter

- ⑤ Fasten the swivel nut.

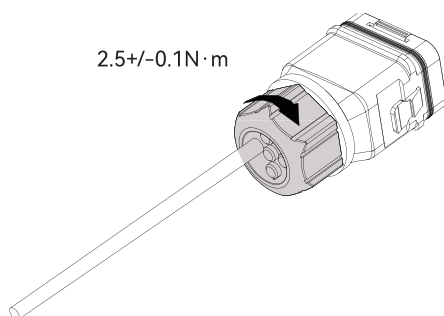

Figure 5-22

▼ 5.5.4 Installing the COM Connector

- ① Remove the waterproof lid from the COM terminal.
- ② Insert the COM connector into COM terminal on the bottom of the inverter until there is an audible click.

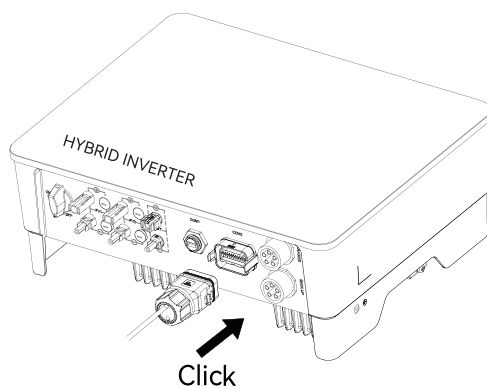

Figure 5-23

▼ 5.5.5 Meter and BMS Communication



NOTE

Before purchasing the battery, you need to make sure the battery you selected is in the battery approval list of manufacturer, otherwise, the system may not work properly. Please contact your installer or our service team for confirmation if you're not sure about it.

RJ45 terminal connection sequence and definition as below.

No.	Color	Meter Side	Battery Side
1	Orange & White	/	RS485_A3
2	Orange	/	RS485_B3
3	Green & White	RS485_B2	/
4	Blue	/	CANH_B
5	Blue & White	/	CANL_B
6	Green	RS485_A2	/
7	Brown & White	RS485_B2	/
8	Brown	RS485_A2	/

Figure 5-24 RJ45 terminal connection sequence and definition

▼ 5.5.6 EMS Communication

An EMS communication cable needs to be connected when to control the operation of a hybrid inverter through the EMS, and communication between EMS and inverter is RS485.

▼ 5.5.7 DI ctrl

DRM and Ripple Control support only one function at the same time.

DRM

DRED (Demand Response Enabling Device) interface is special reserved for Australia and New Zealand according to their safety regulation, and manufacturer doesn't provide the DRED device for the customer. The inverter supports the demand response modes as specified in the standard AS/NZS 4777. The inverter has integrated a terminal block for connecting to a DRED.

4-20kW three phase hybrid inverter

DRED wiring diagram (hybrid inverter) as below:

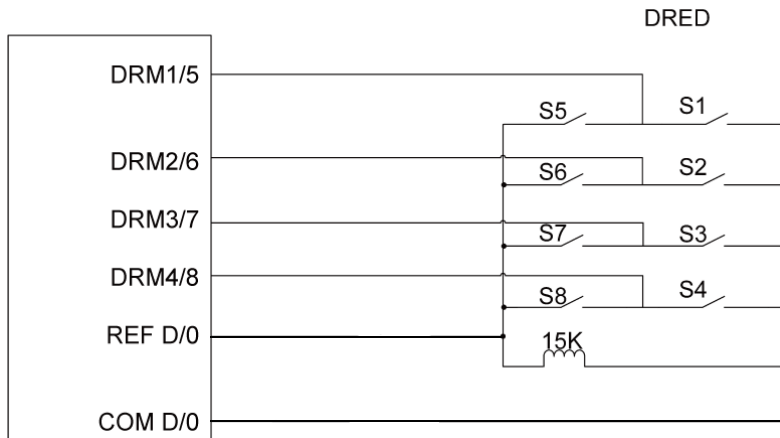

Figure 5-25

DRED mode as shown in table below:

Mode	Function
DRM 0	Operate the disconnection device
DRM 1	Do not consume power
DRM 2	Do not consume at more than 50% of rated power
DRM 3	Do not consume at more than 75% of rated power and source reactive power if capable
DRM 4	Increase power consumption (subject to constraints from other active DRMs)
DRM 5	Do not generate power
DRM 6	Do not generate at more than 50% of rated power
DRM 7	Do not generate at more than 75% of rated power and sink reactive power if capable.
DRM 8	Increase power generation (subject to constraints from other active DRMs)
Priority	DRM1 > DRM2 > DRM3 > DRM4
	DRM5 > DRM6 > DRM7 > DRM8



NOTE

There is a resistor between 15(COM D/0) and 16(REF D/0), do not move the resistor while wiring.

RCR

RCR (Ripple Control Receiver) interface is special reserved for Germany and some other European country according to their safety regulation, and manufacturer doesn't provide the RCR device for the customer.

In Germany and some European areas, a ripple control receiver is used to convert a power grid dispatching signal to a dry contact signal. The dry contact is required for receiving the power grid dispatching signal.

RCR wiring diagram (hybrid inverter) as below:

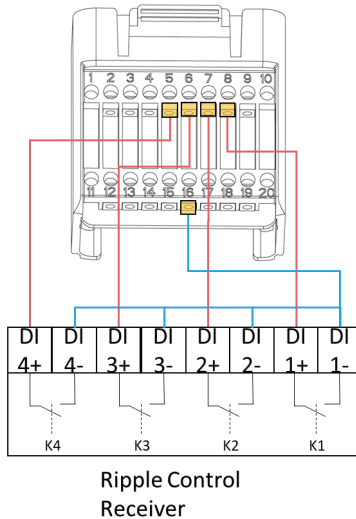

Figure 5-26

RCR operation mode as shown in table below:

Switch mode (External RCR device)	Feed-in output power (in % of the Rated AC output power)
K1 turn on	100%
K2 turn on	60%
K3 turn on	30%
K4 turn on	0%

RCR priority: K1<K2<K3<K4

4-20kW three phase hybrid inverter

▼ 5.5.8 Multifunction Relay

The inverter is equipped with a multifunction dry contact relay, which helps turn the loads on or off when an extra contactor is connected, or startup the diesel generator when the diesel generator startup signal is connected.



Maximum voltage and current at DO dry contact port: 230VAC 1A/
30VDC 1A.



For more installation and setup information, please contact us.

Load Control

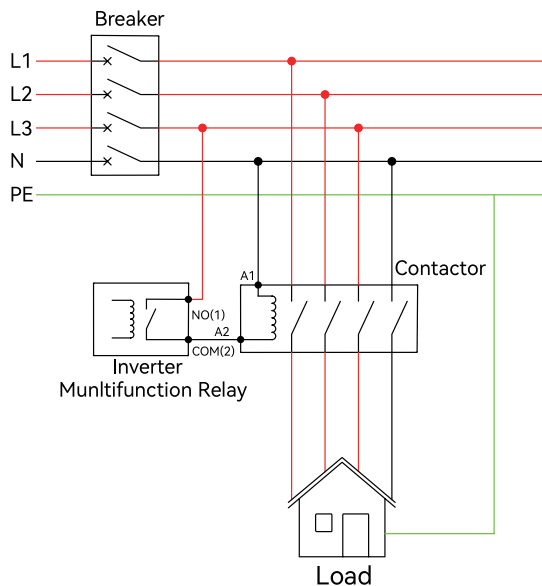

Figure 5-25 Load control connection diagram



NOTE

The AC contactor should be placed between the inverter and the loads. Do not connect the load to DO port directly.

The contactor is not supplied by the manufacturer. Connect the load to the DO port of the inverter directly if the load is designed with a DI port. When the controlled load is connected to ONGRID, the contactor coil must also be connected to ONGRID. When the controlled load is connected to BACKUP, the contactor coil must also be connected to BACKUP.

Generator Control

Inverter Multifunction Relay

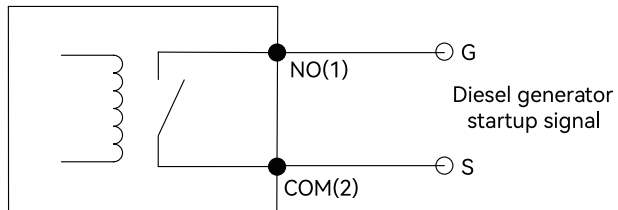
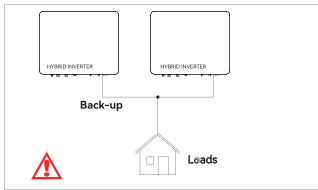

Figure 5-26 Generator Control connection diagram

When the "GEN signal" is active, the open contact (GS) will switch on (no voltage output).

4-20kW three phase hybrid inverter

5.5.9 Parallel System



For the general version, back-up cannot connect in parallel. For advanced applications, please contact our after-sales department.

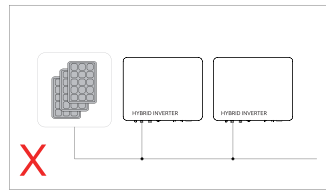

Single PV string cannot connect to multiple inverters.

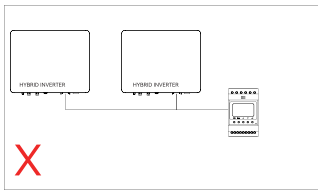

One meter cannot be connected to multiple inverters. Different CTs cannot connect to the same line cable.

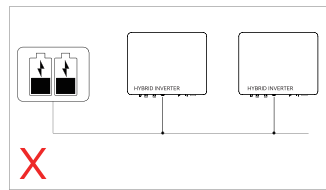

One battery bank cannot be connected to multiple inverters.

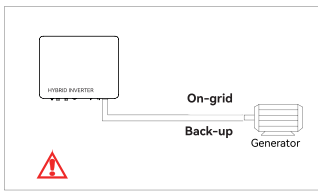

The on-grid and back-up side cannot be connected to and generator directly. For advanced applications, please contact our after-sales department.

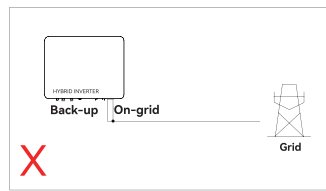

The back-up side cannot be connected on-grid side or grid.

Figure 5-27



For more installation and setup information about parallel system, please contact manufacturer.

▼ 5.5.10 Emergency stop

4-20kW 3Phase comes standard with Emergency stop function, and you can use this function by connecting an external switch into the Emergency stop interface if it requires in the installation place. The external switch doesn't include in our accessory box.

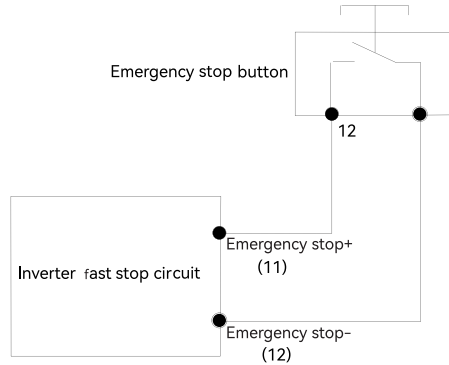

Figure 5-28 Emergency stop connection diagram

5.6 PV String Connection



DANGER

High voltage may be present in the inverter!

Ensure all cables are voltage-free before performing electrical operations.

Do not connect the DC switch and AC circuit breaker before finishing electrical connection.



NOTICE

For best practice, ensure PV modules of the same model and specifications are connected in each string.



WARNING

PV Max. Input voltage is 950V without battery, or 850V with battery, otherwise inverter will be waiting

4-20kW three phase hybrid inverter

5.6.1 PV Side Requirements

System Layout of Units with external DC Switch

① Local standards or codes may require PV systems that fit with an external DC switch on the DC side. The DC switch must be able to safely disconnect the open-circuit voltage of the PV array plus a safety reserve of 20%. Install a DC switch to each PV string to isolate the DC side of the inverter.

② The DC switch has to be certified by AS 60947.3:2018 and AS/NZS IEC 60947.1:2020 in Australia and New Zealand market. The Max. current of the DC switch matching with 4-20kW 3Phase hybrid inverter is no less than 40A. We recommend the following electrical connection.

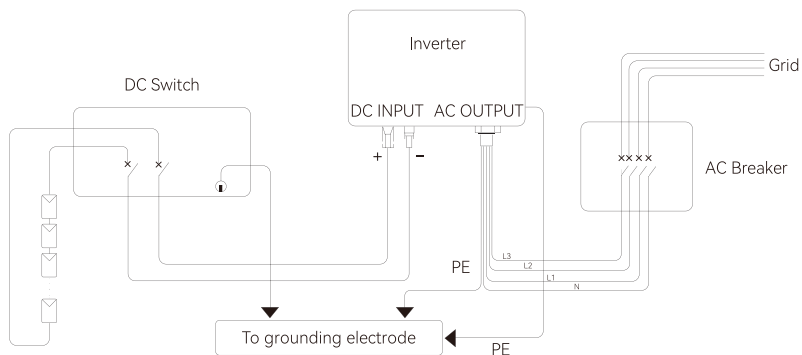

Figure 5-29

Select the appropriate photovoltaic cable

Cable requirements		Cable stripping length
Outside diameter	Conductor core section	
5.9-8.8 mm	4 mm ²	7 mm

5.6.2 Assembling the PV Connector



WARNING

Before assembling the DC connector, make sure that the cable polarity is correct.



Please distinguish U-profile pin (PV terminal) and O-profile pin (Battery terminal). Recommended for crimping U-profile pin with "Phoenix CRIMPFOX-RC 10 - Indent Crimping pliers"

- ① Peel off the DC cable insulation sleeve for 7 mm.



Figure 5-30

- ② Disassemble the connector in the accessory bag.

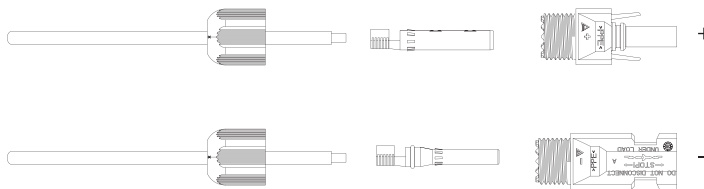

Figure 5-31

- ③ Insert the DC cable through the DC connector nut into the metal terminal and press the terminal with a professional crimping plier (pull back the cable with some power to check if the terminal is well connected to the cable).

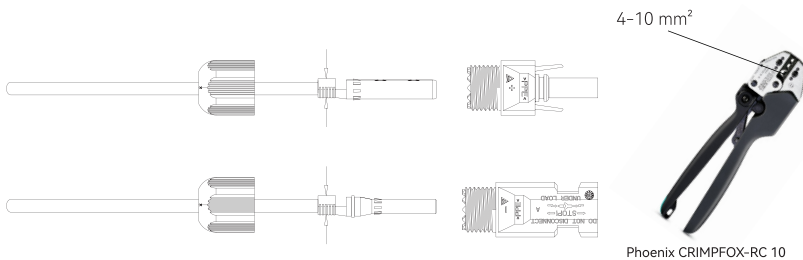

Figure 5-32

- ④ Insert the positive and negative cables into the corresponding positive and negative connectors, pull back the DC cable to ensure that the terminal is tightly attached in the connector.
- ⑤ Use an open-end wrench to screw the nut to the end to ensure that the terminal is well sealed.

4-20kW three phase hybrid inverter

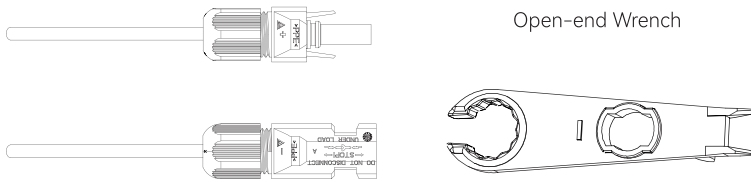

Figure 5-33

5.6.3 Installing the PV Connector

- ① Rotate the DC switch to “OFF” position.

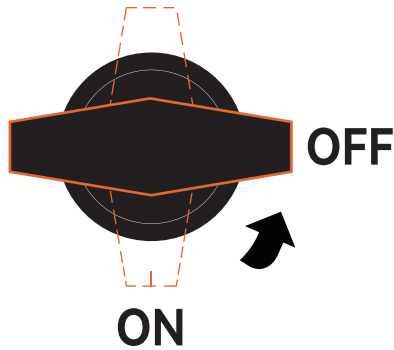

Figure 5-34

- ② Check the cable connection of the PV string for polarity correctness and ensure that the open circuit voltage in any case does not exceed the inverter input limit of 1,000V.PV Max. Input voltage is 950V without battery, or 850V with battery, otherwise inverter will be waiting.

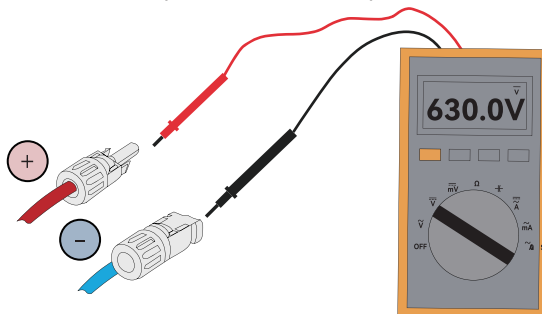

Figure 5-35

- ③ Insert the positive and negative connectors into the inverter DC input terminals respectively, a click sound should be heard if the terminals are well connected.

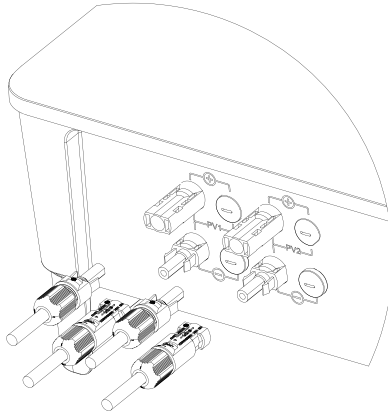



Figure 5-36

- ④ Seal the unused PV terminals with the terminal caps.

5.7 Power Cable of the Battery Connection

NOTE

Please contact your battery supplier for detailed battery installation information.

▼ 5.7.1 The following principles must be considered when making battery connection:

- ① Disconnect the AC breaker on the grid side.
- ② Disconnect the breaker on the battery side.
- ③ Turn the inverter DC switch to the “OFF” position.
- ④ Make sure the maximum input voltage of battery is within the inverter limitation.

▼ 5.7.2 Lithium battery connector assembly procedures

Select an appropriate DC cable

Cable requirements		Cable stripping length	Applicable models
Outside diameter	Conductor core section		
5.0-8.0 mm	6 mm ²	8 mm	4-12kW-25A 10-20kW-40A
	10 mm ²	10 mm	10-20kW-40A

CAUTION

If the conductor core of the battery cable is too small, which may cause poor contact between the terminal and the cable, please use the cable specified in the above table, or contact manufacturer to purchase terminals of other specifications.

- ① Peel off the battery cable insulation sleeve for 10 mm.



Figure 5-37

- ② Disassemble the connector in the accessory bag.



Please distinguish U-profile pin (PV terminal) and O-profile pin (Battery terminal). Recommended for crimping O-profile pin with "Phoenix CRIMPFOX 10S - Square Crimping pliers"

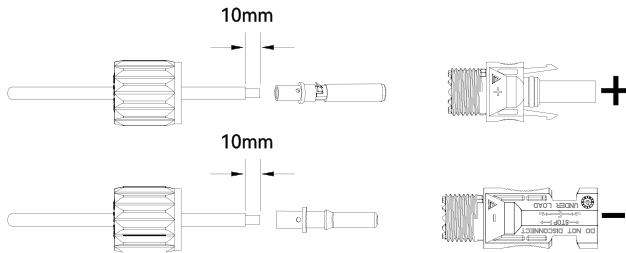

Figure 5-38

③ Insert the battery cable through the battery connector nut into the metal terminal and press the terminal with a professional crimping plier (pull back the cable with some power to check if the terminal is well connected to the cable).

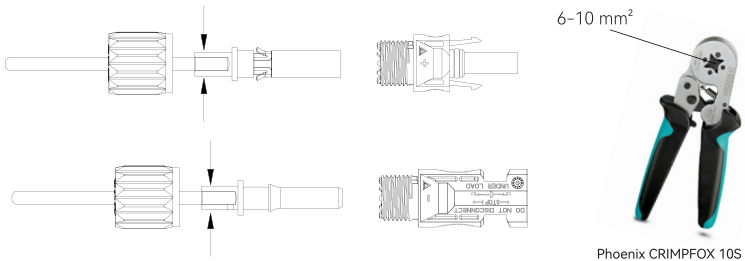

Figure 5-39

④ Insert the positive and negative cables into the corresponding positive and negative connectors, pull back the battery cable to ensure that the terminal is tightly attached in the connector.

⑤ Use an open-end wrench to screw the nut to the end to ensure that the terminal is well sealed.

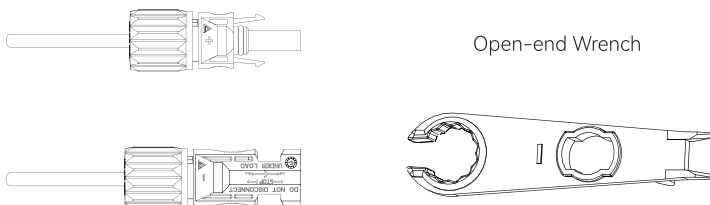

Figure 5-40

4-20kW three phase hybrid inverter



① Before making the battery connector, please make sure the polarity of the cable is correct.

② Use a multimeter to measure the voltage of the battery pack and make sure the voltage is within the inverter limitation and the polarity is correct.

④ Insert the positive and negative connector into the inverter battery terminals respectively, and a “click” sound represents the assembly in place.

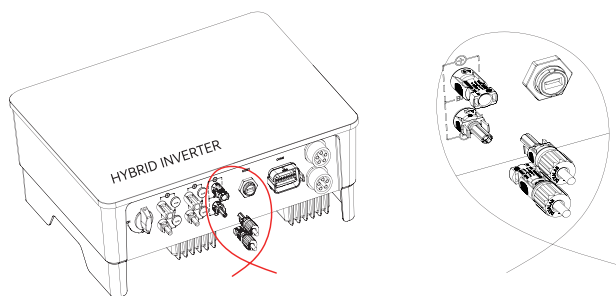

Figure 5-41

6 Commissioning

6.1 App Preparation

- ① Install the Local configuration App and Cloud monitoring App with latest version. Refer to "8.2 Cloud monitoring App and 8.3 Local configuration App".
- ② Register an account on the Cloud monitoring App. If you have got the account and password from the distributor/installer or manufacturer, skip this step.

6.2 Inspection Before Commissioning

Check the following items before starting the inverter:

- ① All equipment has been reliably installed.
- ② DC switch and AC circuit breaker are in the "OFF" position.
- ③ The ground cable is properly and reliably connected.
- ④ The AC cable is properly and reliably connected.
- ⑤ The DC cable is properly and reliably connected.
- ⑥ The communication cable is properly and reliably connected.
- ⑦ The vacant terminals are sealed.
- ⑧ No foreign items, such as tools, are left on the top of the machine or in the junction box (if there is).
- ⑨ The AC circuit breaker is selected in accordance with the requirements of this manual and local standards.
- ⑩ All warning signs & labels are intact and legible.

6.3 Commissioning Procedure

If all of the items mentioned above meet the requirements, proceed as follows to start up the inverter for the first time.

- ① Turn on the AC breaker.
- ② Turn on the lithium battery switch. Power on the battery pack manually if a battery is equipped.
- ③ Turn on the DC switch, the DC switch may be integrated in the inverter or installed by the customer.
- ④ The inverter will work properly after turning on the DC and AC breakers on the condition the weather and grid meet requirements. The time for entering the operating mode may vary according to the chosen safety code.
- ⑤ Observe the LED indicator to ensure that the inverter operates normally.

4-20kW three phase hybrid inverter

④ After the inverter is started, please refer to the [QUICK USE GUIDE] which is attached to the access to configure the inverter.



If the inverter does not work properly, check the country code and battery ID Settings.

- ① Select the safety code suitable for the country (region) where the inverter is installed at.
- ② Select the battery ID suitable for the battery is installed.



CT AUTO TEST FUNCTION

Hybrid inverter has the function of detecting the installation direction and phase sequence of CT. The system is installed, this function can be enabled on the APP for detection.



SOC RESET FUNCTION

When the inverter is turned on for the first time, the battery will be automatically charged to calibrate the battery SOC. After the battery is charged, this function will be turned off automatically (If you confirm that it is not necessary, you can manually turn off the function. We recommend to enable this function.)

If you need to calibrate the SOC during system use, you can manually enable the function to calibrate the battery SOC on app or inverter screen. After the battery is fully charged, the function is automatically disabled again.

6.4 Stop the Inverter

When turning off the inverter, please follow the steps below:

- ① Shut down the inverter through the APP or the button on the display first.
- ② Disconnect the breakers on the grid and load side.
- ③ Turn off the battery switch, and disconnect the DC breaker on the battery side (if any).
- ④ Wait 30 seconds and then turn the inverter DC switch to the “OFF” position. At this time, there is remaining power in the inverter capacitor. Wait for 10 minutes until the inverter is completely de-energized before operating.
- ⑤ Disconnect the AC and DC cables.

7 Operation

When the inverter is turned on, the following interfaces will be displayed on the OLED display, and the OLED display allows the user to check various operation information and to modify the settings of the inverter.



NOTE

If the parameter is a number short press to change the number, long press to confirm the number and jump to the next number. Please wait for 10 seconds and the inverter will automatically save your settings or modifications.

7.1 Main Window

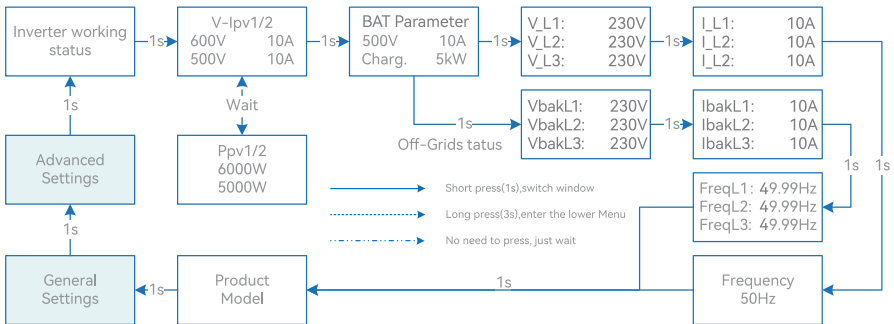

Inverter working status
Waiting/Checking/On-Grid/Off-Grid/Fault Info/FW Updating

Inverter Display Abbreviation and Complete Name Reference Table

Abbreviation	Complete Name
V-Ipv1/2	PV input voltage and current of each MPPT
Ppv1/2	PV input power of each MPPT
BAT Parameter	Battery Parameter
Charg.	Charge
Dischg.	Discharge
V_V_L1: / V_V_L2: / V_V_L3:	Three-phase AC voltage (On-Grid status)
VbakL1: / VbakL2: / VbakL3:	Three-phase AC voltage (Off-Grid status)
I_L1: / I_L2: / I_L3:	Inverter output current (On-Grid status)
IbakL1: / IbakL2: / IbakL3:	Inverter output current (Off-Grid status)
FreqL1: / FreqL2: / FreqL3:	Inverter output Frequency (Off-Grid status)
FW Updating	Firmware Updating

7.2 General Setting

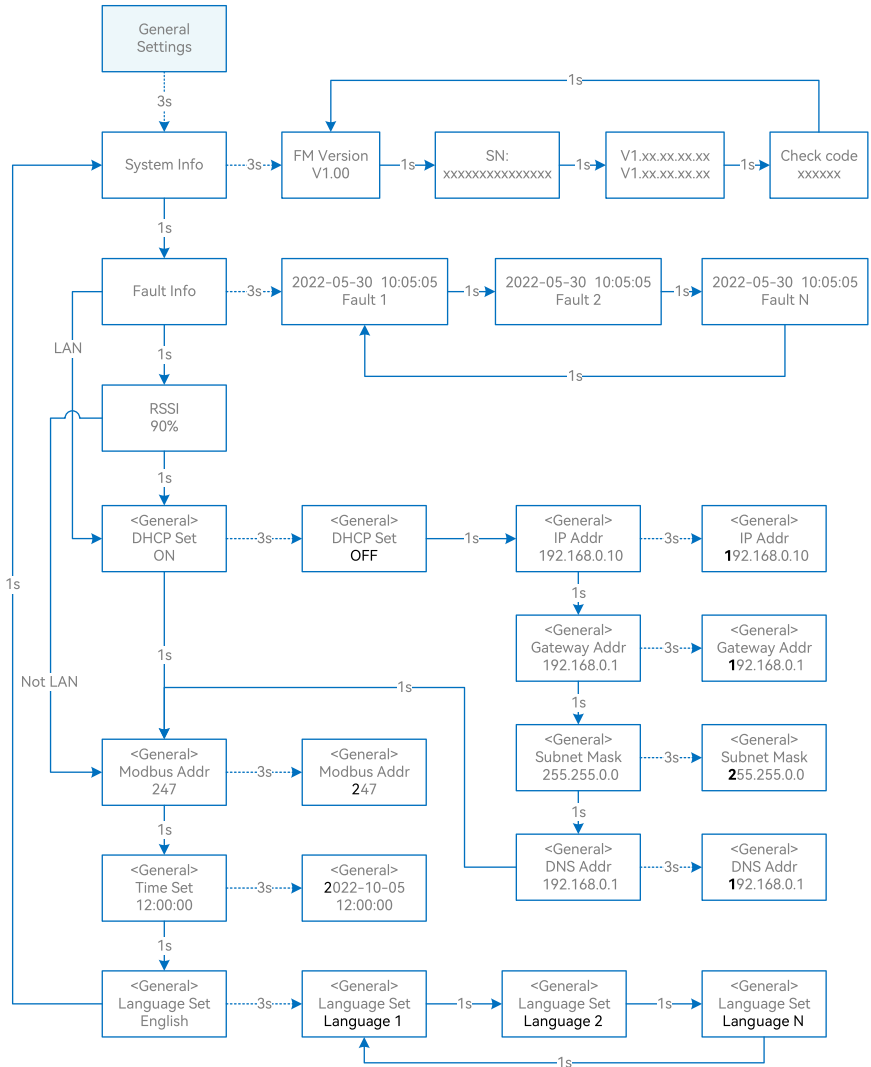

Inverter Display Abbreviation and Complete Name Reference Table

Abbreviation	Complete Name
System Info	System information
FM Version	Firmware version
SN	Series number
Fault Info	Fault information
RSSI	Received signal strength indicator
DHCP Set	Enable or disable DHCP functionality
IP Addr	If DHCP is turned off, set the static IP address
Gateway Addr	If DHCP is turned off, set the Gateway IP address
Subnet Mask	If DHCP is turned off, set the subnet mask
DNS Addr	If DHCP is turned off, set the domain name server address
Modbus Addr	Modbus address

7.3 Advanced Setting

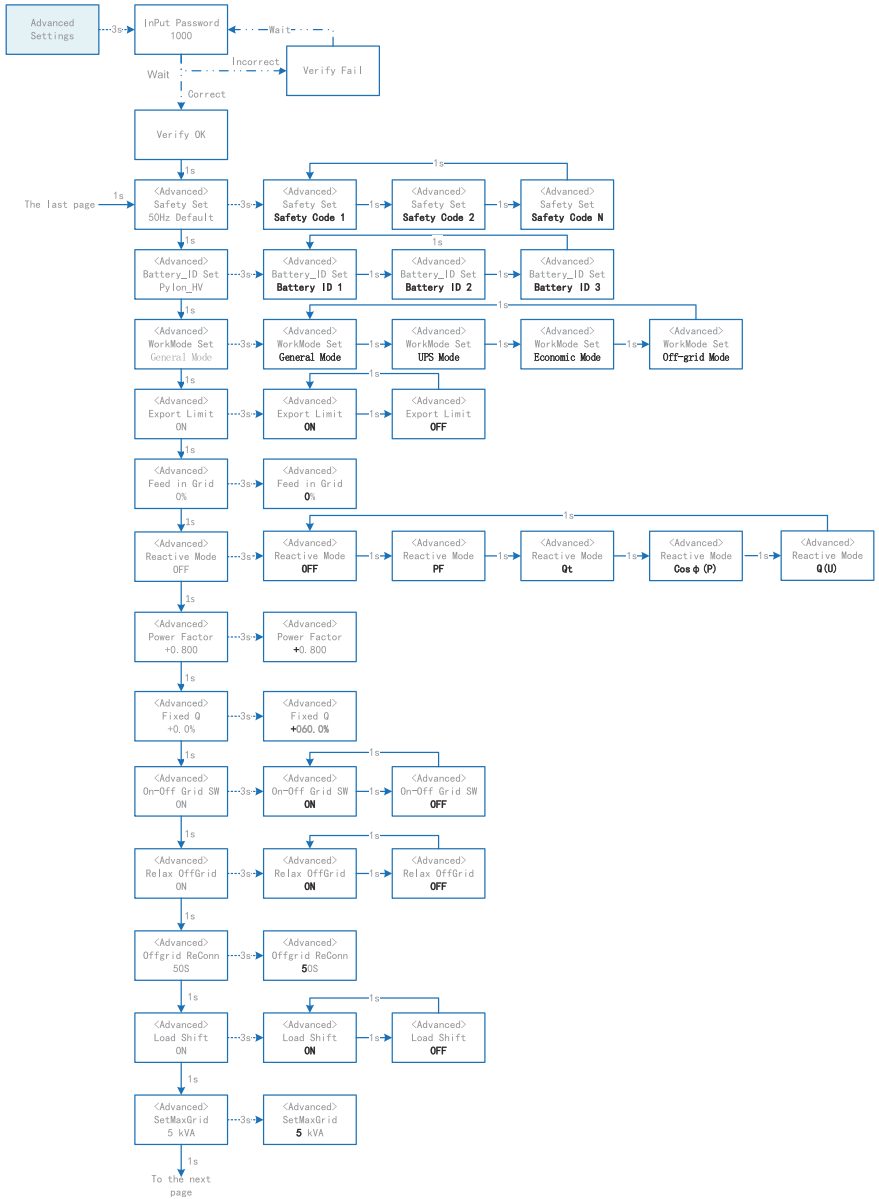

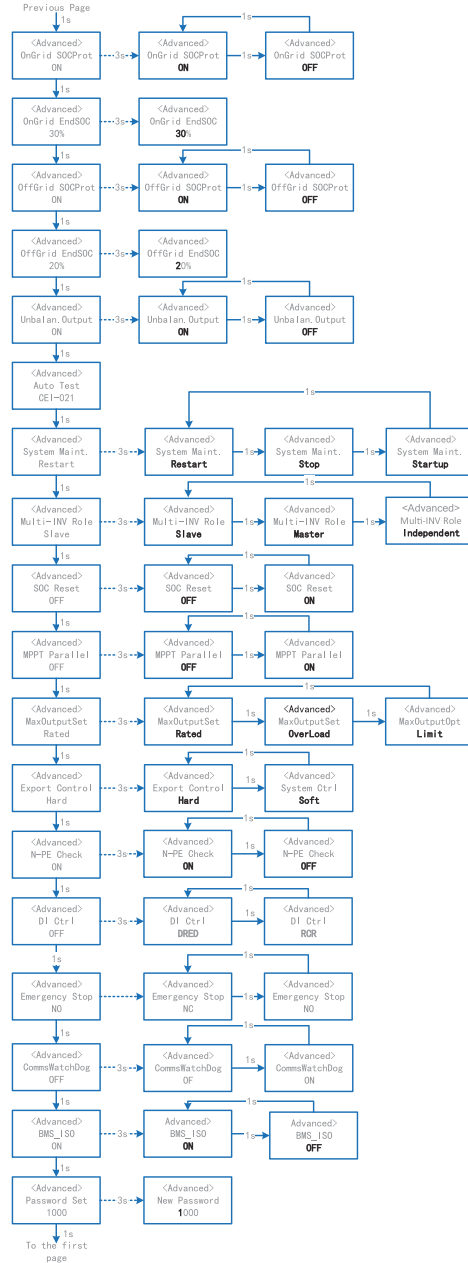

4-20kW three phase hybrid inverter

Inverter Display Abbreviation and Complete Name Reference Table

Abbreviation	Complete Name
Safety Set	Select the code that meet local regulatory requirements
Battery_ID Set	Select the battery model
Work Mode	Current work mode / work mode setting
Export Limit	On-grid export limit function switch
Feed in Grid	Set the percentage of the power that is allowed to feed to the grid
Reactive Modes	Reactive Power Mode
PF	"Under ""Reactive Mode" "The reactive power can be regulated by the parameter PF (Power Factor)."
Qt	"Under ""Reactive Mode" "The reactive power can be regulated by the parameter Q-Var limits (in %)."
Cosφ(P)	"Under ""Reactive Mode" "The PF changes with the output power of the inverter."
Q(U)	"Under ""Reactive Mode" "The reactive power changes with the grid voltage"
Fixed Q	The reactive power ratio when the "Reactive Mode" is Qt.
On-Off Grid SW	Off-grid function switch (If turn it on, the inverter will automatically switch to off-grid mode to ensure the back-up side power supply when the grid is abnormal or off, otherwise, there is no output on the back-up side)
Relax OffGrid	Reduce the switching sensitivity of the On/Off-grid (applied to the places where the grid is unstable or inverter always entered off-grid mode for some reasons)
Offgrid ReConn.	When inverter is operating without grid, it will stop backup output after overload protection, and restart within the set time.
Load Shifting	Peakload shifting function switch
SetMaxGrid	Set max allowed power from grid (under the condition of Peakload Shifting is on)
OnGrid SocProt.	On-grid battery SOC (State of Charge) Protection
OnGrid EndSOC	End-of-discharge SOC of on-grid
OffGrid SocProt.	Off-grid SOC Protection
OffGrid EndSOC	End-of-discharge SOC of off-grid
Unbalan. Output	3-Phase Unbalanced Output Switch when inverter work on On-grid state
System Maint.	System maintenance, includes inverter stop and run, system restart
Multi-INV Role	In the multi-inverter parallel system, set the role of one inverter as the master and the other inverter as the slave.

Abbreviation	Complete Name
SOC Reset	If turned it on, the battery will be automatically charged to calibrate the battery SOC. After the battery is charged, this function will be turned off automatically
MPPT Parallel	If MPPT is connected in parallel, enable this function.
MaxOutputSet	Select the maximum AC output power. Rated, Max. output power= Rated output power on the datasheet Overload, Max. output power= Max. output power on the datasheet Limit, Max. output power < Rated output power on the datasheet
Export Control	In the power export limit on mode, when the communication between the inverter and meter or the inverter and datalogger is interrupted, select the inverter operation mode from one of the follows: Hard, inverter stops Soft, inverter generates power as the "Feed in Grid" value set on the screen
N-PE Check	The N and PE shorting function on the BACK-UP side in the off-grid operation status.
DI Ctrl	DI Ctrl enable "DRM" or "RCR" function
DRM	Demand Response Modes
RCR	Ripple Control Receiver
Emergency Stop	Emergency stop switch device
NO	Normally open:Emergency Switch Normally Open, when switch closed, inverter stop.
NC	Normally closed: Emergency Switch Normally Closed, when switch open, inverter stop.
CommsWatchDog	When the function is turned on, the inverter stops working when communication with the master is lost.

7.4 Country Code (Safety Code) Setting

Please set "Country code (Safety code)" under the menu "Safety Set" in "Advanced Settings". Refer to "7.3 Advanced Setting" for more information.

7.5 Auto-Test

This function is disabled by default, and will be only functional in the safety code of Italy. Short press the button several times until "Auto Test CEI 0-21" displays on the screen, press and hold the button 3 seconds to activate "Auto Test". After the auto test is finished, short press the button several times until the screen displays "Auto Test Record", and hold the button 3 seconds to check the test results.

The auto test will start when the correct test item is selected, and the test result will be displayed on the screen when it finished. If the test was successful, it will display "Test Pass", otherwise will display "Test Fail". After each item tested, the inverter will reconnect to the grid and automatically start the next test according to the requirements of CEI 0-21.

4-20kW three phase hybrid inverter

Connect the AC cable, auto test will start after the inverter connected to the grid, see the operation steps below:

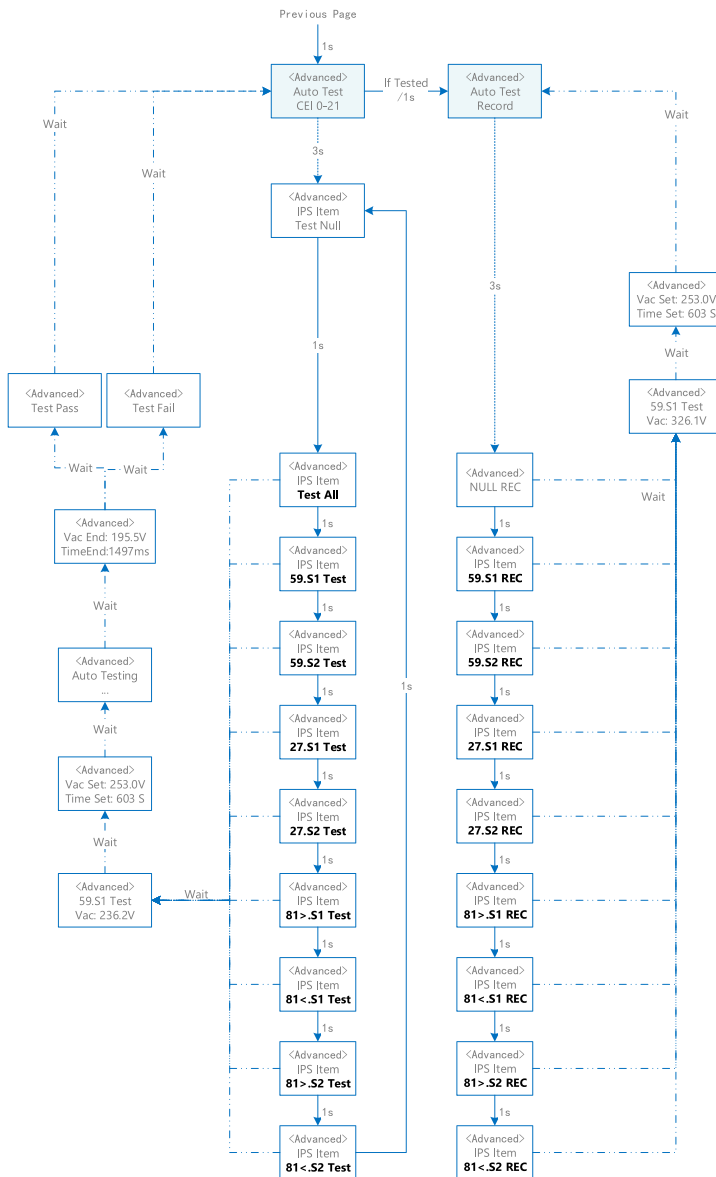

7.6 Reactive Power

The inverter provides a reactive power regulation function.

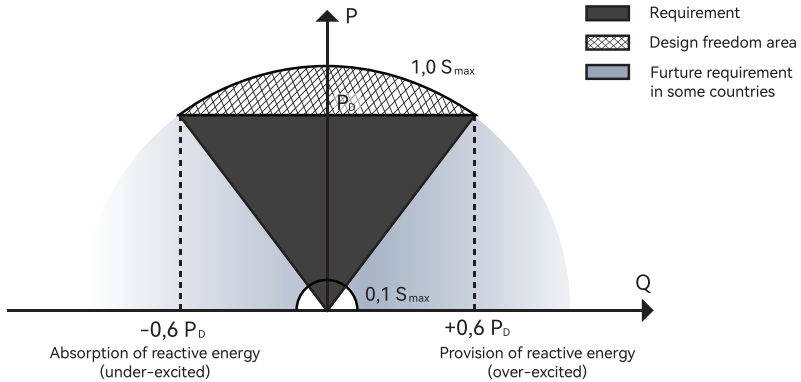

Figure 7-1 Capabilities

This mode can be enabled via configuration software. It is enabled by default in some regions, such as AU, DE market. For information on how to change default setpoints please contact us.

Descriptions of reactive power regulation mode:

Mode	Descriptions
Off	The PF is fixed at +1.000.
PF	The reactive power can be regulated by the parameter PF (Power Factor).
Qt	The reactive power can be regulated by the parameter fixed Q(in Pn%).
$\cos\varphi(P)$	The PF changes with the output power of the inverter.
Q(U)	The reactive power changes with the grid voltage.

▼ 7.6.1 “Off” Modes

The reactive power regulation function is disabled. The PF is limited to +1.000.

▼ 7.6.2 “PF” Mode

The power factor is fixed and reactive power setpoint is calculated according to the current power. The PF ranges from 0.8 leading to 0.8 lagging.

Leading: the inverter is sourcing reactive power to the grid.

Lagging: the inverter is injecting reactive power into the grid.

4-20kW three phase hybrid inverter

▼ 7.6.3 “Qt” Mode

In the Qt mode, system rated reactive power is fixed, and the system injects reactive power according to the delivered reactive power ratio.

The setting range of the reactive power ratio is -60%~60%, corresponding to the ranges of inductive and capacitive reactive power regulation respectively.

▼ 7.6.4 “Cosφ(P)” Mode

The PF of the inverter output varies in response to the output power of the inverter.

“Cosφ(P)” Mode Parameter Descriptions:

Parameter	Explanation	Range
Cosφ(P)_P1(Point A)	Output power at P1 on the Cosφ(P) mode curve (in percentage)	10% ~ 100%
Cosφ(P)_P2(Point B)	Output power at P2 on the Cosφ(P) mode curve (in percentage)	20% ~ 100%
Cosφ(P)_P3(Point C)	Output power at P3 on the Cosφ(P) mode curve (in percentage)	20% ~ 100%
Cosφ(P)_K1(Point A)	Power factor at P1 on the Cosφ(P) mode curve	0.8 ~ 1
Cosφ(P)_K2(Point B)	Power factor at P2 on the Cosφ(P) mode curve	
Cosφ(P)_K3(Point C)	Power factor at P3 on the Cosφ(P) mode curve	
Cosφ(P)_Enter-Voltage	Voltage percentage for Cosφ(P) function activation	100% ~ 110%
Cosφ(P)_Exit-Voltage	Voltage percentage for Cosφ(P) function deactivation	90% ~ 100%

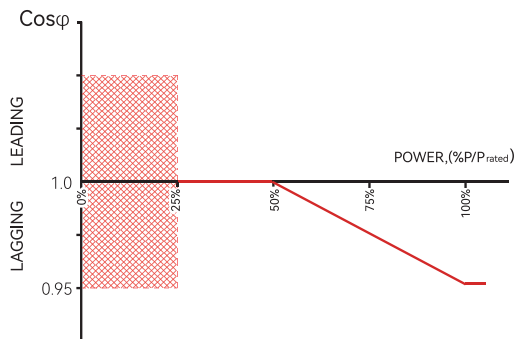

Figure 7-2 Cosφ(P) Curve

▼ 7.6.5 “Q(U)” Mode

The reactive power output of the inverter will vary in response to the grid voltage.
 “Q(U)” Mode Parameter Descriptions:

Parameter	Explanation	Range
QU_V1	Grid voltage limit at P1 on the Q(U) mode curve	80% ~ 100%
QU_Q1	Value of Q/Sn at P1 on the Q (U) mode curve	0 ~ 60%
QU_V2	Grid voltage limit at P2 on the Q(U) mode curve	80% ~ 100%
QU_Q2	Value of Q/Sn at P2 on the Q (U) mode curve	-60% ~ 60%
QU_V3	Grid voltage limit at P3 on the Q(U) mode curve	100% ~120%
QU_Q3	Value of Q/Sn at P3 on the Q (U) mode curve	-60% ~ 60%
QU_V4	Grid voltage limit at P4 on the Q(U) mode curve	100% ~120%
QU_Q4	Value of Q/Sn at P4 on the Q(U) mode curve	0 ~ -60%
QU_Enter-Power	Active power for Q(U) function activation	20% ~ 100%
QU_Exit-Power	Active power for Q(U) function deactivation	1% ~ 20%

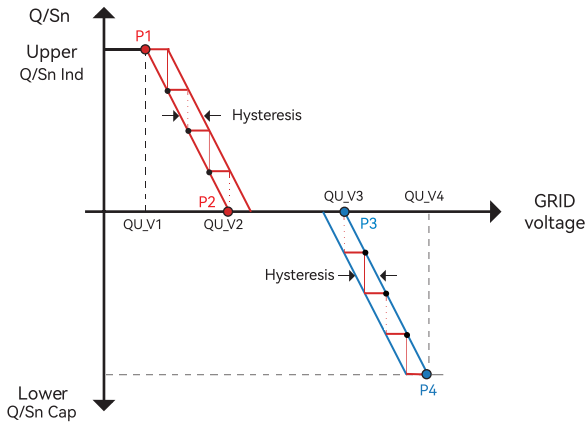

Figure7-3 Q(U) Curve

8 Monitoring

8.1 Monitoring Device

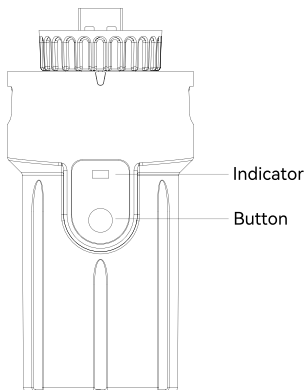

Figure 8-1 Monitoring device display interface

Indicator Status	Description
Off	Connection abnormal
Always On	Communicate with the server normally
Slow flashing	The monitoring device is not connected to the router or is not connected to the base station.
Quick flashing	The monitoring device is connected to the router or connected to the base station but not connected to the server.

Button	Description
Press 1 second	Reset device, the indicator goes off for 2 seconds, then flashes normally.
Press 5 second	Restore factory default settings, the indicator goes off for 2 seconds, then flashes once every 2 seconds, until the factory restore is completed.



NOTE

The WiFi module needs to be configured to the router for the first installation. If the router name or password are changed, the WiFi devices will need to be reconfigured. For details, please refer to the [QUICK USE GUIDE] which is attached to the accessory bag.

If DHCP is enabled on the router, the LAN version module does not need to be configured. Otherwise, please refer to the [QUICK USE GUIDE] which is attached to the accessory bag.

8.2 Cloud monitoring App

Manufacturer inverter provides a monitoring port that can collect and transmit data from the inverter to manufacturer monitoring platform via an external monitoring device. Please refer to the product nameplate on side of enclosure to get the monitoring application. If download issues exist, contact your dealer or manufacturer technical support.

8.3 Local configuration App

Local configuration App is designed for quick configuration of manufacturer hybrid inverters, offering features such as safety code, battery brand and type, work modes, and off-grid application settings through WiFi direct connection, etc.

Please refer to the product nameplate on side of enclosure to get the application. If download issues exist, contact your dealer or manufacturer technical support.

9 Troubleshooting

9.1 Error Message

4-20kW 3-phase hybrid inverter is designed in accordance with grid operation standards, and conform to the requirements of safety and EMC. The inverter had passed a series of rigorous tests to ensure it runs sustainably and reliably before shipment.

When a fault occurs, the corresponding error message will be shown on the OLED display, and in this case, the inverter might stop feeding into grid. The fault messages and their corresponding troubleshooting methods are listed below:

Error Message	Description	Solution
Mains Lost	Grid power outage, AC switch or circuit is disconnected.	<ol style="list-style-type: none"> 1. Check whether the mains supply is lost. 2. Check whether the AC breaker and terminal are well connected.
Grid Voltage Fault	Inverter detects that the grid voltage exceeds the limit of selected safety set range.	<ol style="list-style-type: none"> 1. Check whether the safety code is correct. 2. Check whether the AC cable wiring is correct. 3. Check whether the voltage increased cause by large AC cable impedance. In this case we could replce with a thicker AC cable. 4. Extend the voltage protection limit with the permission of the Electricity Authority.
Grid Frequency Fault	Grid over frequency or underfrequency, the grid frequency is higher or lower than the set protection value.	<ol style="list-style-type: none"> 1. Check whether the AC cable is correct and well connected. 2. Change to another country with wider protection range if it's allowed by the local electricity company.
DCI Fault	Inverter detects that the the direct current injection value exceeds the range.	<ol style="list-style-type: none"> 1. Restart the inverter. 2. Seek for help from the installer or manufacture.

Error Message	Description	Solution
ISO Over Limitation	Inverter detects that DC side's insulation impedance to the ground is too low.	<ol style="list-style-type: none"> 1. Check whether PV panels, cables, and connectors are waterlogged or damaged. 2. Use a megger to measure ground resistance on the DC side, and the measured value should not be less than 500 KΩ. 3. Seek help from the installer or manufacture.
GFCI Fault	The inverter detects that the ground leakage current exceeds the limitation.	<ol style="list-style-type: none"> 1. Restart the inverter. 2. Check whether the PV panels, cables, and connectors are waterlogged or damaged. 3. Seek help from the installer or manufacture.
PV Over Voltage	PV input voltage exceeds the upper limit.	Reduce the number of PV panels to make sure that the open-circuit voltage of each string is lower than the inverter maximum allowed input voltage.
Bus Voltage Fault	The voltage of bus circuit is too high	<ol style="list-style-type: none"> 1. Check whether the input voltage exceeds the limit. 2. Restart the inverter. 3. Seek help from the installer or manufacture.
Inverter Over Temperature	The inverter detects its high internal temperature	<ol style="list-style-type: none"> 1. Check whether the inverter installation location is well ventilated. 2. Try to turn it off for a while, and then power it back on when it cools down. 3. Seek help from the installer or manufacture.
N-PE Check Fault	The ground cable is loose or in poor connection	Check whether the ground cable wiring is correct.
SPI Fault	Internal communication got failed. Caused by a strong external magnetic field etc.	<ol style="list-style-type: none"> 1. Restart the inverter. 2. Seek help from the installer or manufacture.

4-20kW three phase hybrid inverter

Error Message	Description	Solution
E2 Fault	Internal storage got abnormal. Caused by a strong external magnetic field etc.	<ol style="list-style-type: none"> 1. Restart the inverter. 2. Seek help from the installer or manufacture.
GFCI Device Fault	GFCI device got abnormal	<ol style="list-style-type: none"> 1. Restart the inverter. 2. Seek for help from the installer or manufacture.
AC Transducer Fault	AC transducer got abnormal	<ol style="list-style-type: none"> 1. Restart the inverter. 2. Seek for help from the installer or manufacture.
Relay Check Fail	Self-checking of internal relay got failed. Neutral & ground cable are in poor connection on AC side.	<ol style="list-style-type: none"> 1. Use multimeter to measure the voltage between N&PE cable on AC side. If the voltage is higher than 10V, which means the neutral or ground connection is abnormal. 2. restart the inverter. 3. Seek help from the installer or manufacture.
Internal Fan Fault	Inverter's internal fan got failed	<ol style="list-style-type: none"> 1. Restart the inverter. 2. Seek for help from the installer or manufacture.
External Fan Fault	Inverter's external fan got failed	<ol style="list-style-type: none"> 1. Check whether the fan is blocked by foreign matters, clean them if necessary.
Bat OV	Battery protection got triggered	<ol style="list-style-type: none"> 1. Check working status of battery. 2. Check if battery is alarming.

Error Message	Description	Solution
Backup OV	Abnormal voltage exists on the back-up side	Turn off inverter and remove the back-up connector. Use a multimeter to measure whether there is voltage existing on the back-up connector.
Bus Volt Low	Abnormal power scheduling	Check whether the battery voltage or PV input voltage is normal
Hard Fault	Hardware protection got triggered	<ol style="list-style-type: none"> 1. Restart the inverter. 2. Seek help from the installer or manufacture.
Backup OP	Output power over limitation on back-up side	Check whether the load power on back-up side exceeds the maximum output power of inverter.
Inverter OV	The load power exceeds the range of its limit of inverter in off-grid mode	<ol style="list-style-type: none"> 1. Check whether there is an impact load on the back-up side and whether the load power is too high. 2. Check whether back-up side is short circuit.
Inverter OF	The load power exceeds the range of its limit of inverter in off-grid mode	<ol style="list-style-type: none"> 1. Check whether there is an impact load on the back-up side and whether the load power is too high. 2. Check whether back-up side is short circuit.
Inverter OC	The load power exceeds the range of its limit of inverter in off-grid mode	<ol style="list-style-type: none"> 1. Check whether there is an impact load on the back-up side and whether the load power is too high. 2. Check whether back-up side is short circuit.

4-20kW three phase hybrid inverter

Error Message	Description	Solution
SCI Fault	Internal communication got failed. Caused by a strong external magnetic field etc.	<ol style="list-style-type: none"> 1. Restart the inverter. 2. Seek for help from the installer or manufacture.
FLASH Fault	Internal storage anomaly. Caused by a strong external magnetic field etc.	<ol style="list-style-type: none"> 1. Restart the inverter. 2. Seek for help from the installer or manufacture.
Meter Comm Fault	Abnormal communication between meter and inverter.	<ol style="list-style-type: none"> 1. Check whether the communication connection between inverter and meter is reliable 2. Confirm whether the meter model is compatible
BMS Comm Fault	Abnormal communication between inverter and battery BMS.	<ol style="list-style-type: none"> 1. Check whether the battery ID selection is correct. 2. Check whether the communication connection between inverter and BMS is reliable 3. Check the working status of battery.

9.2 Inverter Maintenance



Incorrect operation do cause the risk of inverter damage or personal injury.

Please strictly follow the steps below.

- ① select 'stop' option on inverter screen or monitoring app to shut down inverter.
- ② Turn off the AC breaker on utility grid side.
- ③ Turn off inverter DC switch.
- ④ Turn off the battery switch, and disconnect the DC breaker on the battery side (if any).
- ⑤ Wait for 10 minutes to ensure the energy of capacitor is fully dissipated.
- ⑥ Confirm all the indicator lights are off.



Keep unprofessional person away.

A temporary alarm sign or barrier must be posted to keep unprofessional person away while performing electrical connection and maintenance.



Any Arbitrary replacement of internal components is forbidden.

Please seek help from manufacturer for maintenance support. Otherwise, we will not take any responsibility.



Please remember not to do the self-maintenance before being familiar with the proper instruction of the whole process.

4-20kW three phase hybrid inverter

Items	Methods	Period
System clean	Check dust or foreign matter on the heat-sink, air inlet and outlet.	Once 6-12 months
Electrical connection	Check whether the cables are in good connection.	Once 6-12 months
Sealing	Check whether all the terminals and ports are properly sealed. Reseal the cable hole if it is aging or not sealed.	Once a year

9.3 Battery Maintenance

Installation and maintenance of batteries should be performed or supervised with professional knowledge about batteries.

Please contact your battery supplier for detailed installation and maintenance information.



Do not dispose battery in fire, or it may explode.
Do not dismantle or break the battery. The electrolyte inside would be harmful to your body.



The battery has risk of electrical shock, the following scenario should be noticed during the operation.

- a) Remove metal items from your body.
- b) Use insulated tools.
- c) Remove metal items from battery.
- d) Turn off the DC breaker of the battery before assembling or disassembling battery terminals.
- f) There is a risk of electrical shock if battery is unexpectedly grounded. Remove the grounding cable to avoid the electrical shock.

10 Appendix

10.1 Technical Parameters

Model	4kW-25A	5kW-25A
PV Input		
Start-up voltage (V)	135	135
Max. DC input voltage (V)*	1000*	1000*
Rated DC input voltage (V)	620	620
MPPT voltage range (V)*	120-950*	120-950*
No. of MPP trackers	2	2
No. of DC inputs per MPPT	1/1	1/1
Max. input current (A)	15/15	15/15
Max. short-circuit current (A)	20/20	20/20
Battery Side		
Battery type	Lithium Battery (with BMS)	
Battery communication mode	CAN	CAN
Battery voltage range (V)	135-750	135-750
Maximum charging current (A)	25	25
Maximum discharge current (A)	25	25
Grid Side		
Rated output power (kW)	4.0	5.0
Max. output power (kW)	4.4	5.5
Rated output apparent power (kVA)	4.0	5.0
Max. output apparent power (kVA)	4.4	5.5
Max. input apparent power (kVA)	8.0	10.0
Max. charging power of battery (kW)	4.0	5.0
Rated AC voltage (V)	3L/N/PE, 220/380V; 230/400V; 240/415V	
Rated AC frequency (Hz)	50/60	50/60
Rated output current (A)	5.8	7.3

4-20kW three phase hybrid inverter

Model	4kW-25A	5kW-25A
Grid Side		
Max. output current (A)	6.7	8.3
Max. input current (A)	11.6	14.5
Power factor	0.8 leading ...0.8 lagging	
Max. total harmonic distortion	<3% @Rated output power	
DCI	<0.5%In	<0.5%In
Back-up Side		
Rated output power (kW)	4.0	5.0
Max. output power (kW)	4.4	5.5
Rated output apparent power (kVA)	4.0	5.0
Max. output apparent power (kVA)	4.4	5.5
Rated output current (A)	5.8	7.3
Max. output current (A)	6.7	8.3
UPS switching time	<10ms	<10ms
Rated output voltage (V)	3/N/PE, 220/380V; 230/400V; 240/415V	
Rated output frequency (Hz)	50/60	50/60
Peak output apparent power (kVA)	8, 60s	10, 60s
Voltage harmonic distortion	<3% @Linear load	
Efficiency		
Max. efficiency	98.1%	98.1%
European efficiency	97.3%	97.3%
Protection		
DC reverse polarity protection	Integrated	
Battery input reverse connection protection	Integrated	
Insulation resistance protection	Integrated	
Surge protection	Integrated	
Over-temperature protection	Integrated	
Residual current protection	Integrated	
Islanding protection	Integrated (Frequency shift)	

Model	4kW-25A	5kW-25A
Protection		
AC over-voltage protection	Integrated	
Overload protection	Integrated	
AC short-circuit protection	Integrated	
General Data		
Over voltage category	PV: II ; Main: III	
Dimensions (mm)	534*418*210 (W*H*D)	
Weight (KG)	26	26
Protection degree	IP65	IP65
Standby self-consumption (W)	<15	<15
Topology	Transformerless	
Operating Temperature Range (°C)	-30~60	-30~60
Relative Humidity (%)	0~100	0~100
Operating Altitude (m)	3000 (>3000m derating)	
Cooling	Natural Convection	
Noise Level (dB)	<25	<25
Display	OLED & LED	
Communication	CAN, RS485, WiFi/LAN (Optional)	

4-20kW three phase hybrid inverter

Model	6kW-25A	8kW-25A
PV Input		
Start-up voltage (V)	135	135
Max. DC input voltage (V)*	1000*	1000*
Rated DC input voltage (V)	620	620
MPPT voltage range (V)*	120-950*	200-950*
No. of MPP trackers	2	2
No. of DC inputs per MPPT	1/1	1/1
Max. input current (A)	15/15	15/15
Max. short-circuit current (A)	20/20	20/20
Battery Side		
Battery type	Lithium Battery (with BMS)	
Battery communication mode	CAN	CAN
Battery voltage range (V)	135-750	135-750
Maximum charging current (A)	25	25
Maximum discharge current (A)	25	25
Grid Side		
Rated output power (kW)	6.0	8.0
Max. output power (kW)	6.6	8.8
Rated output apparent power (kVA)	6.0	8.0
Max. output apparent power (kVA)	6.6	8.8
Max. input apparent power (kVA)	12.0	16.0
Max. charging power of battery (kW)	6.0	8.0
Rated AC voltage (V)	3L/N/PE, 220/380V; 230/400V; 240/415V	
Rated AC frequency (Hz)	50/60	50/60
Rated output current (A)	8.7	11.6
Max. output current (A)	10.0	13.3
Max. input current (A)	17.4	23.2
Power factor	0.8 leading ...0.8 lagging	

Model	6kW-25A	8kW-25A
Grid Side		
Max. total harmonic distortion	<3% @Rated output power	
DCI	<0.5%In	<0.5%In
Back-up Side		
Rated output power (kW)	6.0	8.0
Max. output power (kW)	6.6	8.8
Rated output apparent power (kVA)	6.0	8.0
Max. output apparent power (kVA)	6.6	8.8
Rated output current (A)	8.7	11.6
Max. output current (A)	10.0	13.3
UPS switching time	<10ms	<10ms
Rated output voltage (V)	3/N/PE, 220/380V; 230/400V; 240/415V	
Rated output frequency (Hz)	50/60	50/60
Peak output apparent power (kVA)	12, 60s	16, 60s
Voltage harmonic distortion	<3% @Linear load	
Efficiency		
Max. efficiency	98.1%	98.2%
European efficiency	97.3%	97.4%
Protection		
DC reverse polarity protection	Integrated	
Battery input reverse connection protection	Integrated	
Insulation resistance protection	Integrated	
Surge protection	Integrated	
Over-temperature protection	Integrated	
Residual current protection	Integrated	
Islanding protection	Integrated (Frequency shift)	
AC over-voltage protection	Integrated	
Overload protection	Integrated	
AC short-circuit protection	Integrated	

4-20kW three phase hybrid inverter

Model	6kW-25A	8kW-25A
General Data		
Over voltage category	PV: II ; Main: III	
Dimensions (mm)	534*418*210 (W*H*D)	
Weight (KG)	26	26
Protection degree	IP65	IP65
Standby self-consumption (W)	<15	<15
Topology	Transformerless	
Operating Temperature Range (°C)	-30~60	-30~60
Relative Humidity (%)	0~100	0~100
Operating Altitude (m)	3000 (>3000m derating)	
Cooling	Natural Convection	
Noise Level (dB)	<25	<25
Display	OLED & LED	
Communication	CAN, RS485, WiFi/LAN (Optional)	

Model	10kW-25A	12kW-25A
PV Input		
Start-up voltage (V)	135	135
Max. DC input voltage (V)*	1000*	1000*
Rated DC input voltage (V)	620	620
MPPT voltage range (V)*	200-950*	200-950*
No. of MPP trackers	2	2
No. of DC inputs per MPPT	1/1	1/1
Max. input current (A)	15/15	15/15
Max. short-circuit current (A)	20/20	20/20
Battery Side		
Battery type	Lithium Battery (with BMS)	
Battery communication mode	CAN	CAN
Battery voltage range (V)	135-750	135-750
Maximum charging current (A)	25	25
Maximum discharge current (A)	25	25
Grid Side		
Rated output power (kW)	10.0	12.0
Max. output power (kW)	11.0 ^①	13.2
Rated output apparent power (kVA)	10.0	12.0
Max. output apparent power (kVA)	11.0 ^②	13.2
Max. input apparent power (kVA)	16.5	16.5
Max. charging power of battery (kW)	10.0	12.0
Rated AC voltage (V)	3L/N/PE, 220/380V; 230/400V; 240/415V	
Rated AC frequency (Hz)	50/60	50/60
Rated output current (A)	14.5	17.4
Max. output current (A)	16.5 ^③	20.0
Max. input current (A)	23.9	23.9
Power factor	0.8 leading ... 0.8 lagging	

4-20kW three phase hybrid inverter

Model	10kW-25A	12kW-25A
Grid Side		
Max. total harmonic distortion	<3% @Rated output power	
DCI	<0.5%In	<0.5%In
Back-up Side		
Rated output power (kW)	10.0	12.0
Max. output power (kW)	11.0	13.2
Rated output apparent power (kVA)	10.0	12.0
Max. output apparent power (kVA)	11.0	13.2
Rated output current (A)	14.5	17.4
Max. output current (A)	16.5	20.0
UPS switching time	<10ms	<10ms
Rated output voltage (V)	3/N/PE, 220/380V; 230/400V; 240/415V	
Rated output frequency (Hz)	50/60	50/60
Peak output apparent power (kVA)	20, 60s	20, 60s
Voltage harmonic distortion	<3% @Linear load	
Efficiency		
Max. efficiency	98.2%	98.2%
European efficiency	97.4%	97.4%
Protection		
DC reverse polarity protection	Integrated	
Battery input reverse connection protection	Integrated	
Insulation resistance protection	Integrated	
Surge protection	Integrated	
Over-temperature protection	Integrated	
Residual current protection	Integrated	
Islanding protection	Integrated (Frequency shift)	
AC over-voltage protection	Integrated	
Overload protection	Integrated	
AC short-circuit protection	Integrated	

Model	10kW-25A	12kW-25A
General Data		
Over voltage category	PV: II; Main: III	
Dimensions (mm)	534*418*210 (W*H*D)	
Weight (KG)	26	26
Protection degree	IP65	IP65
Standby self-consumption (W)	<15	<15
Topology	Transformerless	
Operating Temperature Range (°C)	-30~60	-30~60
Relative Humidity (%)	0~100	0~100
Operating Altitude (m)	3000 (>3000m derating)	
Cooling	Natural Convection	
Noise Level (dB)	<25	<25
Display	OLED & LED	
Communication	CAN, RS485, WiFi/LAN (Optional)	

4-20kW three phase hybrid inverter

Model	10kW-40A	12kW-40A
PV Input		
Start-up voltage (V)	135	135
Max. DC input voltage (V)*	1000*	1000*
Rated DC input voltage (V)	620	620
MPPT voltage range (V)*	200-950*	200-950*
No. of MPP trackers	2	2
No. of DC inputs per MPPT	2/2	2/2
Max. input current (A)	30/30	30/30
Max. short-circuit current (A)	40/40	40/40
Battery Side		
Battery type	Lithium Battery (with BMS)	
Battery communication mode	CAN	CAN
Battery voltage range (V)	135-750	135-750
Maximum charging current (A)	40	40
Maximum discharge current (A)	40	40
Grid Side		
Rated output power (kW)	10.0	12.0
Max. output power (kW)	11.0 ^①	13.2
Rated output apparent power (kVA)	10.0	12.0
Max. output apparent power (kVA)	11.0 ^②	13.2
Max. input apparent power (kVA)	20.0	24.0
Max. charging power of battery (kW)	10.0	12.0
Rated AC voltage (V)	3L/N/PE, 220/380V; 230/400V; 240/415V	
Rated AC frequency (Hz)	50/60	50/60
Rated output current (A)	14.5	17.4
Max. output current (A)	16.5 ^③	20.0
Max. input current (A)	29.0	34.8
Power factor	0.8 leading ...0.8 lagging	

Model	10kW-40A	12kW-40A
Grid Side		
Max. total harmonic distortion	<3% @Rated output power	
DCI	<0.5%In	<0.5%In
Back-up Side		
Rated output power (kW)	10.0	12.0
Max. output power (kW)	11.0	13.2
Rated output apparent power (kVA)	10.0	12.0
Max. output apparent power (kVA)	11.0	13.2
Rated output current (A)	14.5	17.4
Max. output current (A)	16.5	20.0
UPS switching time	<10ms	<10ms
Rated output voltage (V)	3/N/PE, 220/380V; 230/400V; 240/415V	
Rated output frequency (Hz)	50/60	50/60
Peak output apparent power (kVA)	20, 60s	20, 60s
Voltage harmonic distortion	<3% @Linear load	
Efficiency		
Max. efficiency	98.4%	98.4%
European efficiency	97.5%	97.5%
Protection		
DC reverse polarity protection	Integrated	
Battery input reverse connection protection	Integrated	
Insulation resistance protection	Integrated	
Surge protection	Integrated	
Over-temperature protection	Integrated	
Residual current protection	Integrated	
Islanding protection	Integrated (Frequency shift)	
AC over-voltage protection	Integrated	
Overload protection	Integrated	
AC short-circuit protection	Integrated	

4-20kW three phase hybrid inverter

Model	10kW-40A	12kW-40A
General Data		
Over voltage category	PV: II ; Main: III	
Dimensions (mm)	534*418*210 (W*H*D)	
Weight (KG)	28	28
Protection degree	IP65	IP65
Standby self-consumption (W)	<15	<15
Topology	Transformerless	
Operating Temperature Range (°C)	-30~60	-30~60
Relative Humidity (%)	0~100	0~100
Operating Altitude (m)	3000 (>3000m derating)	
Cooling	Smart fan	
Noise Level (dB)	<40	<40
Display	OLED & LED	
Communication	CAN, RS485, WiFi/LAN (Optional)	

Model	15kW-40A	20kW-40A
PV Input		
Start-up voltage (V)	135	135
Max. DC input voltage (V)*	1000*	1000*
Rated DC input voltage (V)	620	620
MPPT voltage range (V)*	200-950*	200-950*
No. of MPP trackers	2	2
No. of DC inputs per MPPT	2/2	2/2
Max. input current (A)	30/30	30/30
Max. short-circuit current (A)	40/40	40/40
Battery Side		
Battery type	Lithium Battery (with BMS)	
Battery communication mode	CAN	CAN
Battery voltage range (V)	135-750	135-750
Maximum charging current (A)	40	40
Maximum discharge current (A)	40	40
Grid Side		
Rated output power (kW)	15.0	20.0
Max. output power (kW)	16.5 ^⑤	22.0
Rated output apparent power (kVA)	15.0	20.0
Max. output apparent power (kVA)	16.5 ^⑤	22.0
Max. input apparent power (kVA)	30.0	30.0
Max. charging power of battery (kW)	15.0	20.0
Rated AC voltage (V)	3L/N/PE, 220/380V; 230/400V; 240/415V	
Rated AC frequency (Hz)	50/60	50/60
Rated output current (A)	21.7	29.0
Max. output current (A)	25.0 ^⑥	33.5
Max. input current (A)	43.5	43.5
Power factor	0.8 leading ...0.8 lagging	

4-20kW three phase hybrid inverter

Model	15kW-40A	20kW-40A
Grid Side		
Max. total harmonic distortion	<3% @Rated output power	
DCI	<0.5%In	<0.5%In
Back-up Side		
Rated output power (kW)	15.0	20.0
Max. output power (kW)	16.5	22.0
Rated output apparent power (kVA)	15.0	20.0
Max. output apparent power (kVA)	16.5	22.0
Rated output current (A)	21.7	29.0
Max. output current (A)	25.0	33.5
UPS switching time	<10ms	<10ms
Rated output voltage (V)	3/N/PE, 220/380V; 230/400V; 240/415V	
Rated output frequency (Hz)	50/60	50/60
Peak output apparent power (kVA)	25, 60s	25, 60s
Voltage harmonic distortion	<3% @Linear load	
Efficiency		
Max. efficiency	98.4%	98.4%
European efficiency	97.5%	97.5%
Protection		
DC reverse polarity protection	Integrated	
Battery input reverse connection protection	Integrated	
Insulation resistance protection	Integrated	
Surge protection	Integrated	
Over-temperature protection	Integrated	
Residual current protection	Integrated	
Islanding protection	Integrated (Frequency shift)	
AC over-voltage protection	Integrated	
Overload protection	Integrated	
AC short-circuit protection	Integrated	

Model	15kW-40A	20kW-40A
General Data		
Over voltage category	PV: II ; Main: III	
Dimensions (mm)	534*418*210 (W*H*D)	
Weight (KG)	31	31
Protection degree	IP65	IP65
Standby self-consumption (W)	<15	<15
Topology	Transformerless	
Operating Temperature Range (°C)	-30~60	-30~60
Relative Humidity (%)	0~100	0~100
Operating Altitude (m)	3000 (>3000m derating)	
Cooling	Smart fan	
Noise Level (dB)	<40	<40
Display	OLED & LED	
Communication	CAN, RS485, WiFi/LAN (Optional)	

- 1) G98: 10.5kW
- 2) G98: 10.5kVA
- 3) G98: 16.00A
- 4) AS 4777.2: 15.0kW
- 5) AS 4777.2: 15.0kVA
- 6) AS 4777.2: 21.7A

*PV Max. Input voltage is 950V without battery, or 850V with battery, otherwise inverter will be waiting.

10.2 Customer Complaint Guide

Should you have any question about this product, please contact us.

We need the following information to provide you the best assistance:

- Model of the device
- Serial number of the device
- Date of the device
- Fault code/name
- Brief description of the problem



HYBRID INVERTER THREE PHASE



M11-00029-00