



# User Manual



## ML100-12.8 A

Lithium Iron Phosphate (LiFePO<sub>4</sub>) Battery

12.8V100Ah

# PRODUCT OVERVIEW

## 12.8V100Ah BATTERY

Operating Voltage: 12.8V

Charging Voltage:  $14.6 \pm 0.2V$

Recommend charge Current: 25A

max Continuous Discharge current: 100A

max Continuous output Power: 1280W

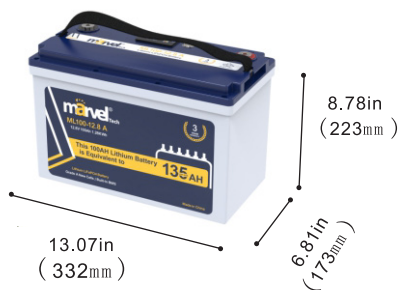
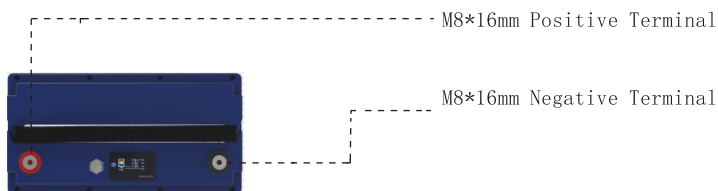

## ADDITIONAL COMPONENTS

The terminal bolts are used to secure multiple cable lugs to a single battery terminal. The bolts can be replaced with M8 bolts of other lengths based on actual needs.

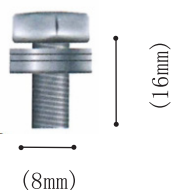

# IMPORTANT SAFETY INSTRUCTION

**| Please keep the battery away from heat sources, sparks, flames, and hazardous chemicals.**

**| Maintain Adequate Ventilation and Heat Dissipation**

Place the battery in a well-ventilated area with sufficient heat dissipation to prevent overheating and damage.

**| Size the Battery Cables and Connectors Appropriately**

Use high-stranded copper connectors and heavy gauge cables to handle possible battery loads. Make sure to keep identical cable lengths.

Avoid accidents caused by unsuitable connectors or cables that make the connection a heat source during battery operation.

**| Please tighten all cable connections, as loose cable connections can cause terminal meltdown or fire.**

**| DO NOT puncture, drop, crush, burn, penetrate, shake, or strike the battery.**

The battery should be securely fastened during handling to prevent impact or dropping.

It should be safely secured to a solid plane and the cables safely tied to a suitable location to avoid arcing and sparking due to friction.

DO NOT press it by placing heavy stuff on top of it for long periods, which may damage it due to an internal short circuit.

**| DO NOT immerse the battery in water whether the battery is in use or on standby.**

**| DO NOT open, dismantle, or modify the battery.**

**| DO NOT touch the exposed electrolyte or powder if the battery casing is damaged.**

**| Uncovered electrolyte or powder that has contacted the skin or eyes MUST be flushed out with plenty of clean water immediately. Seek medical attention afterward.**

**| Avoid Short Circuit**

Please use circuit breakers, fuses, or disconnects that have been properly sized by certified electricians, licensed installers, or regional code authorities to protect all the electrical equipment in your system. The battery has a built-in battery management system (BMS) that protects the battery cells from over-charge, over-discharge, and over-current, however this alone will not protect your system from severe electrical conditions.

**I Trained and certified technicians are required for safe and reliable installation. This product manual can only serve as a guideline as it cannot cover all possible scenarios.**

**I Verify Correct Polarity**

Please verify the polarity before connecting the wiring. Reverse polarity can and will destroy the battery and other electrical equipment. Use a multimeter to determine proper polarity.

**I Avoid Exposed Metal Terminals or Connectors**

The terminals of this battery are always live. Avoid exposed metal terminals or connectors; DO NOT place tools on the terminals or touch them with bare hands; DO NOT short circuit or use outside of specified electrical ratings.

**I DO NOT dispose of the battery as household waste. Please use recycling channels in accordance with local, state, and federal regulations.**

## **WARNING**

**I Batteries are potentially dangerous and proper precautions must be taken during operation and maintenance.**

**I Improper use of the battery can lead to battery failure or other potential damage.**

**I Improper configuration, installation, or use of related equipment in the battery system may damage the battery and other related equipment.**

**I Please wear proper personal protective equipment when working on the battery.**

**I Battery installation and maintenance must be performed by trained and certified technicians.**

**I Failure to follow the warnings above can result in potential damage.**

**If you have any questions or need any help,  
please feel free to contact us (and leave your contact phone number)  
we will offer phone or email support in 12hrs.**

# WHAT TO DO AFTER RECEIVING THE BATTERY

Step  
**1**

**PULL OUT** Insulating Plugs

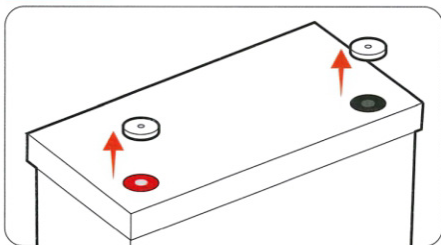

Step  
**2**

**TEST** The Battery Voltage with a Multimeter

≥ 12V To Next Step

< 12V contact us to help resolve the issue

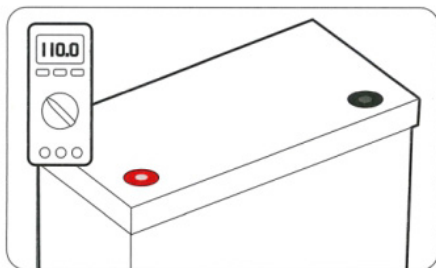

Step  
**3**

**TIGHTLY SCREW IN** Post Bolts

Please tightly screw in the post bolts. Having loose battery terminals will cause the terminals to build up heat resulting in damage to the battery.

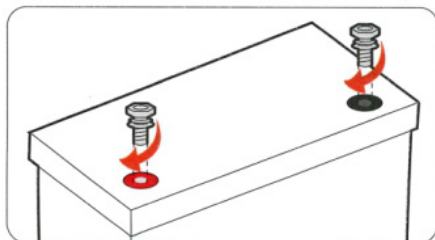

Step  
**4**

**FULLY CHARGE** The Battery  
(Refer to Page 04 for battery charging methods)

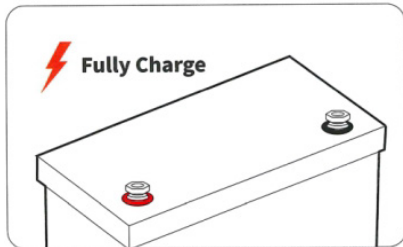

Step  
**5**

**CONNECT** To Use

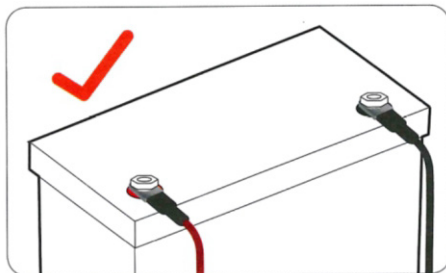

Step  
**6**

**Cover with INSULATING CAPS** when STORED

Please do not cover the post bolts with insulating caps when using the battery.

Please put on the insulating covers to avoid metal or conductive objects touching the positive and negative terminals of the battery at the same time, otherwise it is likely to cause a short circuit.

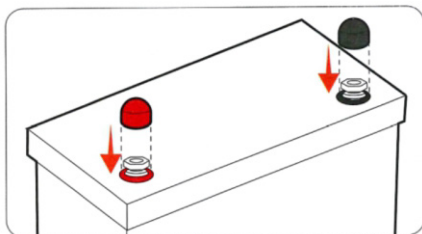

# CONTENTS

BATTERY PARAMETERS ..... PAGE 01-02

RECOMMENDED CABLE SIZING ..... PAGE 03

SERIES/ PARALLEL CONNECTION ..... PAGE 04-07

INVERTER SETTINGS ..... PAGE 08

WHAT TO DO WHEN THE ..... PAGE 09-10  
BATTERY STOPS WORKING?

# BATTERY-PACKMAIN PARAMETERS

Cell	LiFeP04
Nominal Voltage	12. 8V
Rated Capacity	100Ah
Energy	1280W
Internal Resistance	≤40mΩ
Battery Management System (BMS)Board	100A
Charge Method	CC/CV
Charge Voltage	14.6V ±0.2V
Recommend Charge Current	25A
Max. Continuous Charge Current	100A
Max. Continuous Discharge Current	100A
Max.Continuous Output Power	1280W



Dimension	L13.07*W6.81*H8.78inch
	332*173*223mm
Housing Material	ABS
Protection Class	IP 65
Temperature Range	Charge: 0°C to 55°C
	Discharge: -20°C to 60°C
	Storage: 25°C to 30°C



# RECOMMENDED CABLE SIZING

Battery cables should be properly sized to handle the expected load. Refer to the table below for amperage ratings for different sizes of coppercables.

PVC COPPER CABLE SIZE(AWG/mm)	AMPRCITY (A)
14(2.08)	20
12(3.31)	25
10(5.25)	35
8(8.36)	50
6(13.3)	65
4(21.1)	85
2(33.6)	115
1(42.4)	130
1/0(53.5)	150
2/0(67.4)	175
4/0(107)	230

The above values are from NEC Table 310.15(B)16 for copper cables rated at 167°F(75°C) operating at an ambient temperature not exceeding 86°F (30°C). Cables longer than 6 feet (1829 mm) or ambient temperature higher than 86F(30C) may require heavier gauges to avoid excessive voltage drops with undersized ones.

# SERIESPARALLEL CONNECTION

## THE PREMISE OF CONNECTION

To connect in series or and parallel, batteries should meet the below conditions:

- a. identical batteries with the same battery capacity (Ah) and BMS (A);
- b. from the same brand (as lithium battery from different brands has their special BMS);
- c. purchased in near time (within one month).
- D. Standard ambient temperature  $25 \pm 2^{\circ}\text{C}$

## LIMITATION FOR SERIES/PARALLEL CONNECTION

Support connecting up to 16 identical batteries for up to:

4in series as 48V (51.2V) battery system/

4in parallel as 400Ah battery system.

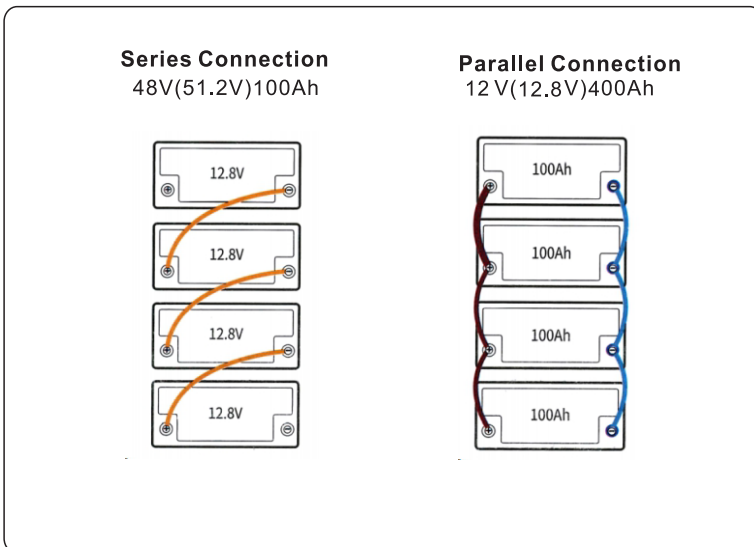

## HOW TO CONNECT BATTERIES

### Notice :

Battery series and parallel steps: first parallel and then series.

### Step1 Wear Insulating Gloves

Wear insulating gloves for protection before connecting. Please pay attention to operation safety in the process of connection.

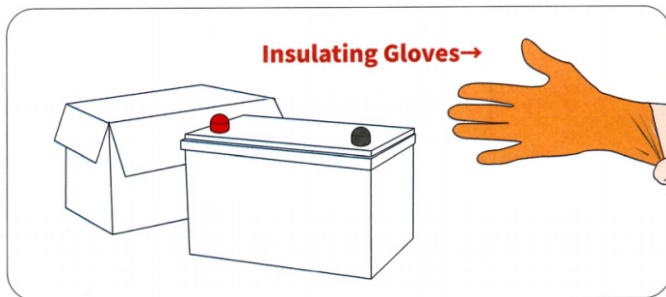

### Step2 Voltage Balancing Before Connection

Below two steps are necessary to reduce the voltage difference between batteries and let the battery system perform the best of it in series or/ and in parallel.

**Step 3** Fully charge the batteries separately.  
(voltage at rest: >13.33V)

**Step 4** Connect all of the batteries in parallel, and leave them together for 12~24hrs.

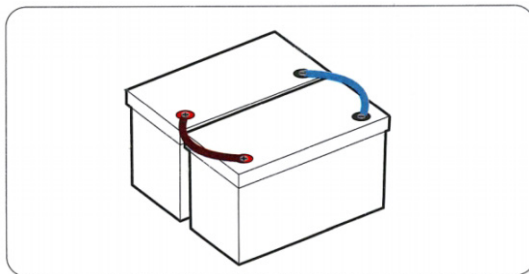

**Step 5** They' re now ready for the connection.

### Step3 Battery-to-Battery Connection

#### #1 Connect Batteries in Series

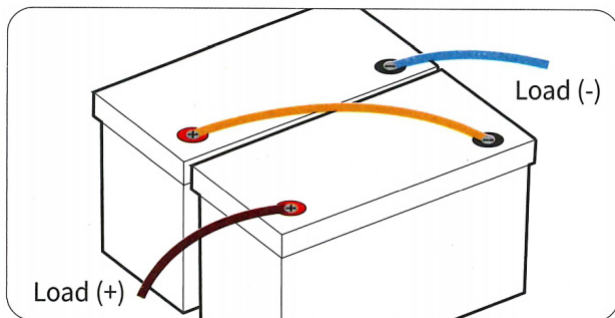

After series connection, the voltage of the battery system will be doubled according to the number of batteries you connect.  
E.g. If two 12.8V100Ah batteries are connected in series, the battery system will be 24V (25.6V)100Ah

#### #2 Connect Batteries in Parallel

Refer to Page 6 for total input & output connection

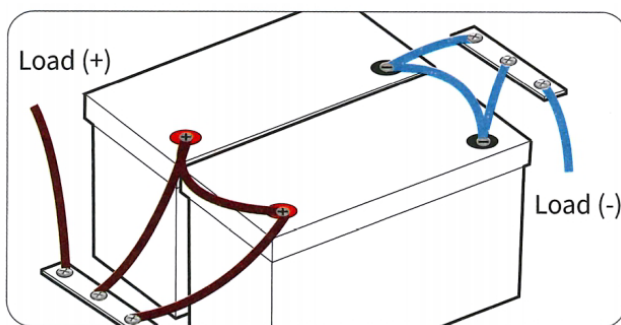

After parallel connection, the capacity of the battery system will be doubled according to the number of batteries you connect.  
E.g. If two 12V100Ah batteries are connected in parallel, the battery system will be 12(12.8V)200Ah

## SERIES/ PARALLEL CONNECTION

2P4S	Battery System	48V(51.2V) 200Ah
	Energy	10,240Wh
	Max.Continuous Charge / Discharge Current	100A
	Max.Continuous Load Power	5120W

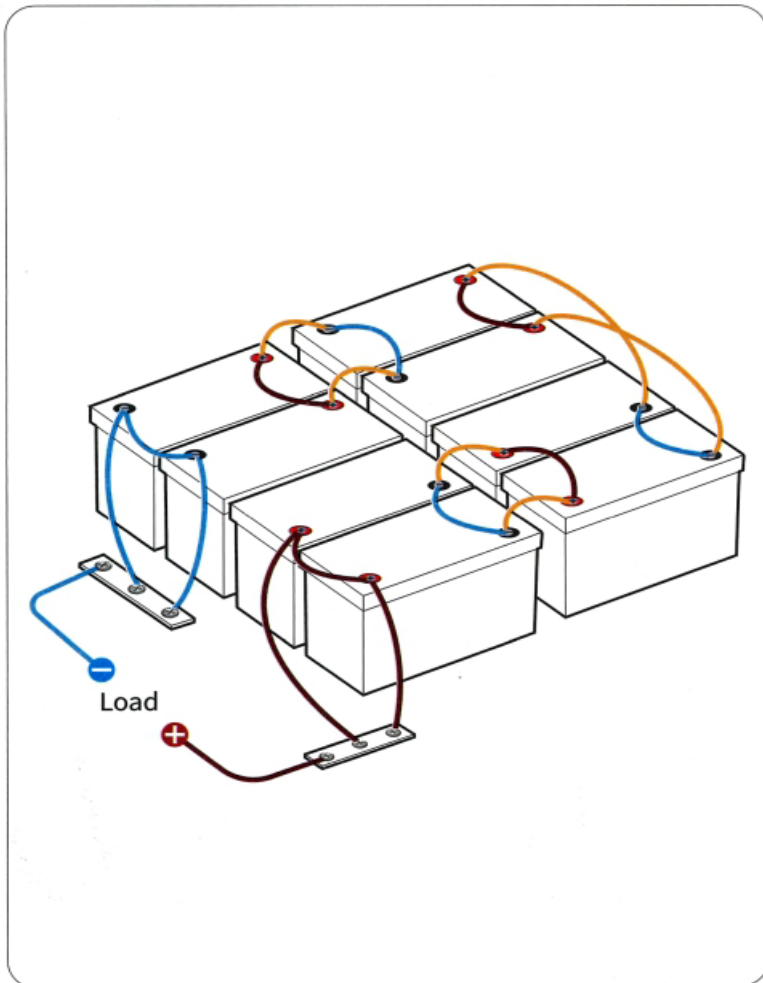

# INVERTER SETTINGS

## METHOD ONE(RECOMMEND)

Select“ 12V(14.6V) L1(LiFePO4) Mode”

## METHOD TWO

If method one is not available, select “User Mode” to enter values according to below parameters.

CHARGING	Charge Voltage	14.6V
	Over Voltage Disconnect	15V
	Over Voltage Reconnect	14.2V
DIS- CHARGING	Under Voltage Warning	11.6V
	Under Voltage Recover	12V
	Low Voltage Disconnect	10.8V
	Low Voltage Reconnect	12.4V

The above setting parameters apply to common inverters on the market (such as Victron, Renogy, Growatt, Xantrex, Go Power, Lux Power. etc). Different brands have slightly different descriptions or naming methods for each parameter. Please directly set the parameters with the same meaning.

If the inverter parameters to be set are special or cannot correspond to one of the above items, please contact for confirmation.

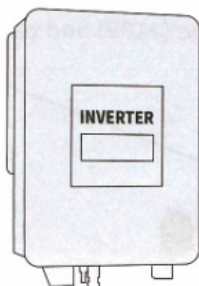

# WHAT TO DO WHEN THE BATTERY STOPS WORKING?

When the battery



or



or



It has 85% chances that BMS has shut it off for protection, and you could try one of below ways to activate the battery.

## GENERAL STEPS

If the BMS has cut off the battery for protection, follow the below steps to activate it.

Cut off all the connections from the battery

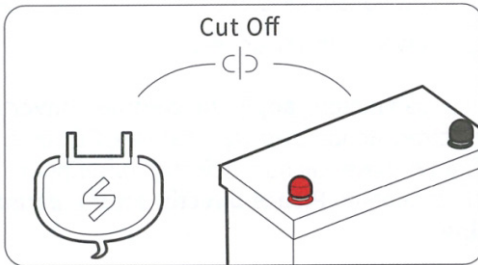

Leave the battery aside for 30mins

Then the battery will automatically recover itself to normal voltage (>10V) and can be used after fully charged.

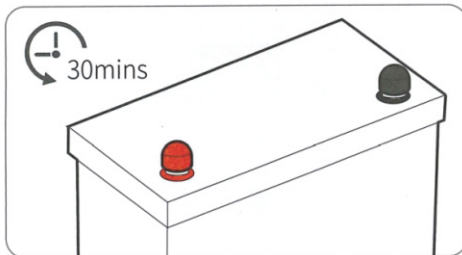



if the battery is unable to recover itself after the above steps, please try activating by ONE OF BELOW TWO METHODS.

After activated (voltage > 10V ) and fully charged by the normal charging method, it can be used normally.

**Method**

Use a charger with a 0v charging function 0 to fully charge the battery.

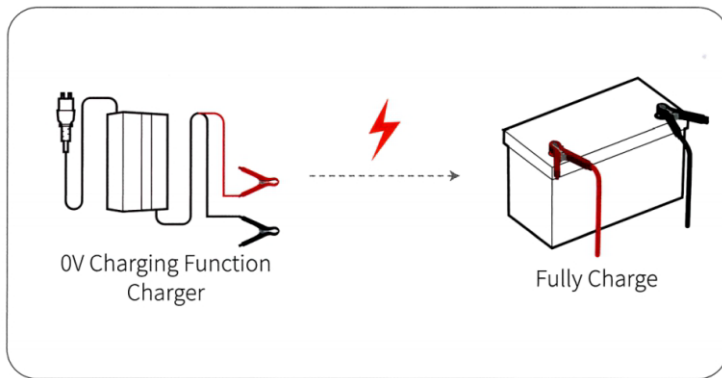

The charger can charge the battery starting from 0V.

**Method**

Connect an 18V~36V solar panel to charge the battery for 3~10s in sunny daytime.

